

STEREO INTEGRATED AMPLIFIER AX-870

SERVICE MANUAL

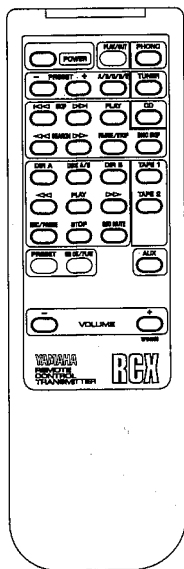
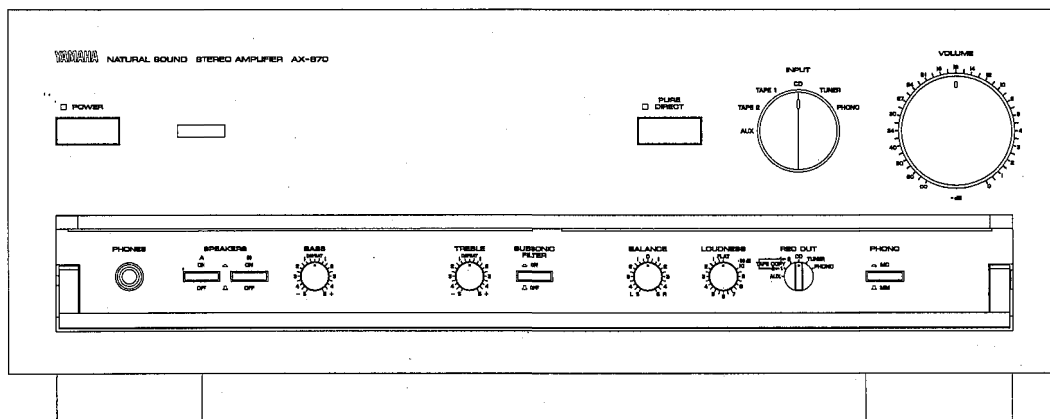

IMPORTANT NOTICE

This manual has been provided for the use of authorized YAMAHA Retailers and their service personnel. It has been assumed that basic service procedures inherent to the industry, and more specifically YAMAHA Products, are already known and understood by the users, and have therefore not been restated.

WARNING: Failure to follow appropriate service and safety procedures when servicing this product may result in personal injury, destruction of expensive components, and failure of the product to perform as specified. For these reasons, we advise all YAMAHA product owners that any service required should be performed by an authorized YAMAHA Retailer or the appointed service representative.

IMPORTANT: The presentation or sale of this manual to any individual or firm does not constitute authorization, certification or recognition of any applicable technical capabilities, or establish a principle-agent relationship of any form.

The data provided is believed to be accurate and applicable to the unit(s) indicated on the cover. The research, engineering, and service departments of YAMAHA are continually striving to improve YAMAHA products. Modifications are, therefore, inevitable and specifications are subject to change without notice or obligation to retrofit. Should any discrepancy appear to exist, please contact the distributor's Service Division.

WARNING: Static discharges can destroy expensive components. Discharge any static electricity your body may have accumulated by grounding yourself to the ground buss in the unit (heavy gauge black wires connect to this buss).

IMPORTANT: Turn the unit OFF during disassembly and part replacement. Recheck all work before you apply power to the unit.

CONTENTS

TO SERVICE PERSONNEL	1	ADJUSTMENTS	5
REAR PANELS	1	PRINTED CIRCUIT BOARD	6-14
SPECIFICATIONS	2	μ-COM DATA	15
BLOCK DIAGRAM	3	SCHEMATIC DIAGRAM	16-17
INTERNAL VIEW	4	PARTS LIST	18-27
DISASSEMBLY PROCEDURES	4	REMOTE CONTROL TRANSMITTER	28

TO SERVICE PERSONNEL

1. Critical Components Information.

Components having special characteristics are marked and must be replaced with parts having specifications equal to those originally installed.

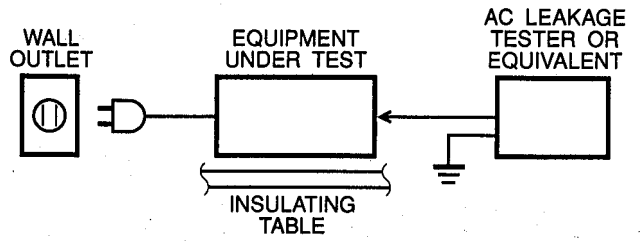

REAR PANELS

▼ A, B models

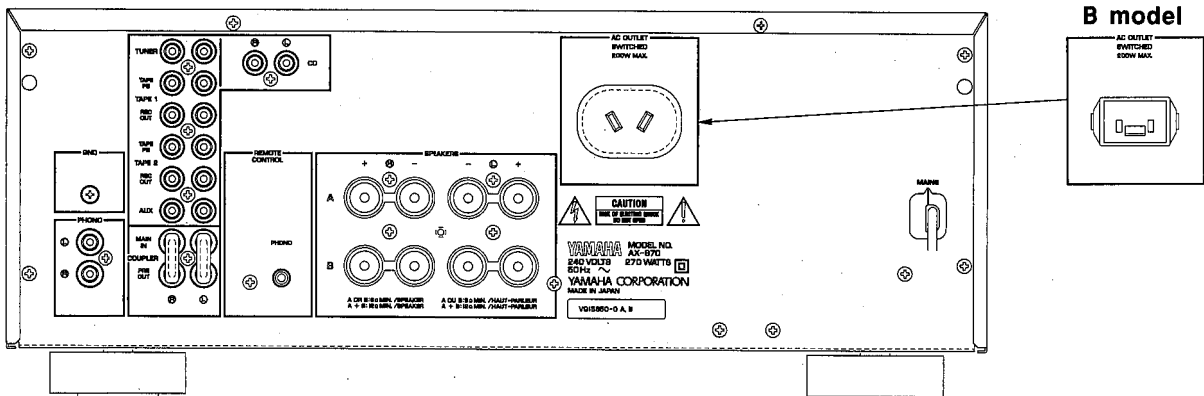

▼ H, W models

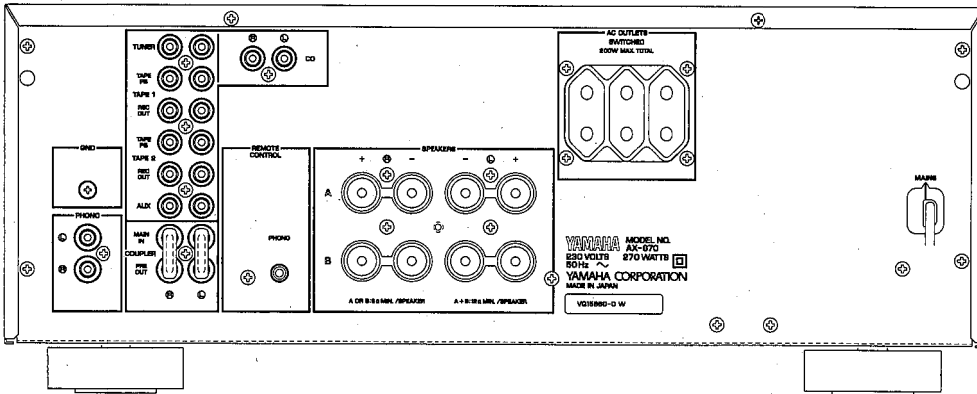

▼ R model

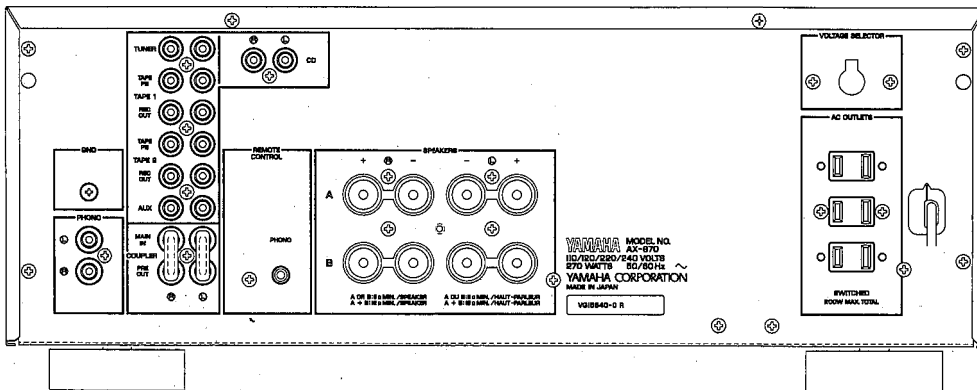

■ SPECIFICATIONS

■ AUDIO SECTION

Minimum RMS Output Power per Channel	
8Ω, 20Hz to 20kHz, 0.015% THD	110W
6Ω, 20Hz to 20kHz, 0.03% THD	130W
Dynamic Power per Channel (IHF)	
8/6/4/2Ω	150/200/230/260W
DIN Standard Output Power Channel	
1kHz, 0.7% THD, 4Ω (H, W models)	185W
Dynamic Headroom	
8/4Ω (R model)	1.35/0.97dB
IEC Power	
1kHz, 0.01% THD, 8Ω (H, W models)	125W
Power Band Width	
8Ω, 55W, 0.03% THD	10Hz to 50kHz
Damping Factor	
8Ω, 20Hz to 20kHz	320 or more
Input Sensitivity/Impedance	
PHONO MC	160μV/220Ω
PHONO MM	2.5mV/47kΩ
CD etc	150mV/47kΩ
MAIN IN	0.9V/47kΩ
Maximum Input Signal Level (1kHz, 0.01% THD)	
PHONO MC	12.5mV
PHONO MM	160mV
Output Level/Impedance	
REC OUT	150mV/2.2kΩ
PRE OUT	1V/1.6kΩ
Maximum Voltage Output	
20Hz to 20kHz, 0.01% THD	1.4V
Headphone Jack Rated Output/Impedance	
0.015% THD, RL= 8Ω	0.5V/470Ω
Frequency Response (20Hz to 20kHz)	
CD etc	0±0.5dB
MAIN IN	0±0.5dB
RIAA Equalization Deviation (20Hz to 20kHz)	
PHONO MC	0±0.5dB
PHONO MM	0±0.3dB
Total Harmonic Distortion (20Hz to 20kHz)	
PHONO MC to REC OUT (3V)	0.007%
PHONO MM to REC OUT (3V)	0.003%
CD etc to PRE OUT (1V)	0.005%
CD etc to SP OUT (55W/8Ω)	0.008%
MAIN IN to SP OUT (55W/8Ω)	0.006%
Signal-to-Noise Ratio (IHF-A Network)	
(Pure Direct SW ON)	
PHONO MC (500μV Input Shorted)	75dB
PHONO MM (5mV Input Shorted)	92dB
CD etc (Shorted)	110dB
Residual Noise (IHF-A Network)	
(Pure Direct SW ON)	
80μV	
Channel Separation (Vol. -30dB)	
PHONO MM•MC (Input Shorted) 1kHz/10kHz	70dB/55dB
CD etc 1kHz/10kHz (Input 5.1kΩ Terminated) ...	65dB/50dB
Tone Control Characteristics	
BASS : Boost/cut	±10dB (20Hz)
Turnover Frequency	350Hz
TREBLE : Boost/cut	±10dB (20kHz)
Turnover Frequency	3.5kHz

Filter Characteristics

Subsonic	15Hz, -18dB/oct
Continuous Loudness Control	-30dB (1kHz)
(Level related equalization)	
Gain tracking error (0dB to -60dB)	±2dB

■ GENERAL

Power Supply

H, W models	AC 230V, 50Hz
A, B models	AC 240V, 50Hz
R model	AC 110/120/220/240V, 60/50Hz

Power Consumption 270W

AC Outlets

Switched x 3	
H, W, R models	200W max. (Total)
Switched x 1	
A, B models	200W max.

Dimensions (W x H x D) 435 x 171 x 448mm
(17-1/8" x 6-3/4" x 17-5/8")

Weight 14kg (30 lbs 13 oz)

Accessories Remote Control Transmitter x 1
Battery (size "AA", R06) x 2

* Specifications subject to change without notice.

H European model B British model
W German model R General model
A Australian model

● DIMENSIONS

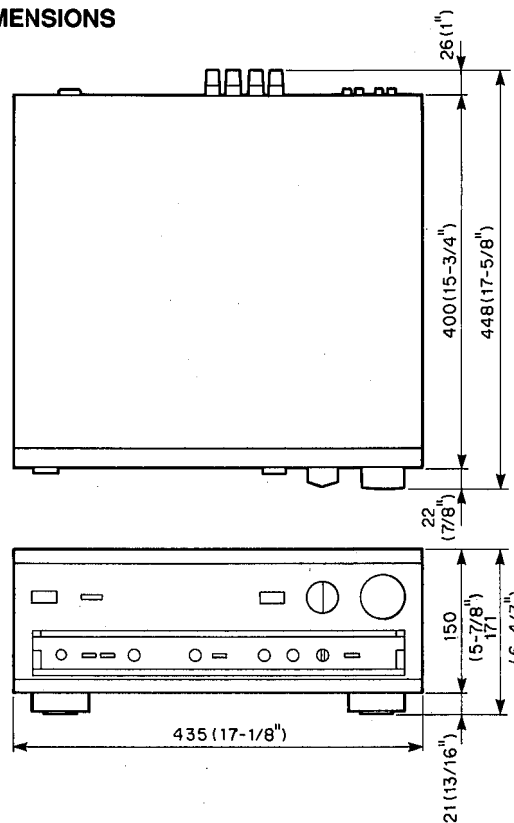

Units : mm (Inch)

■ BLOCK DIAGRAM

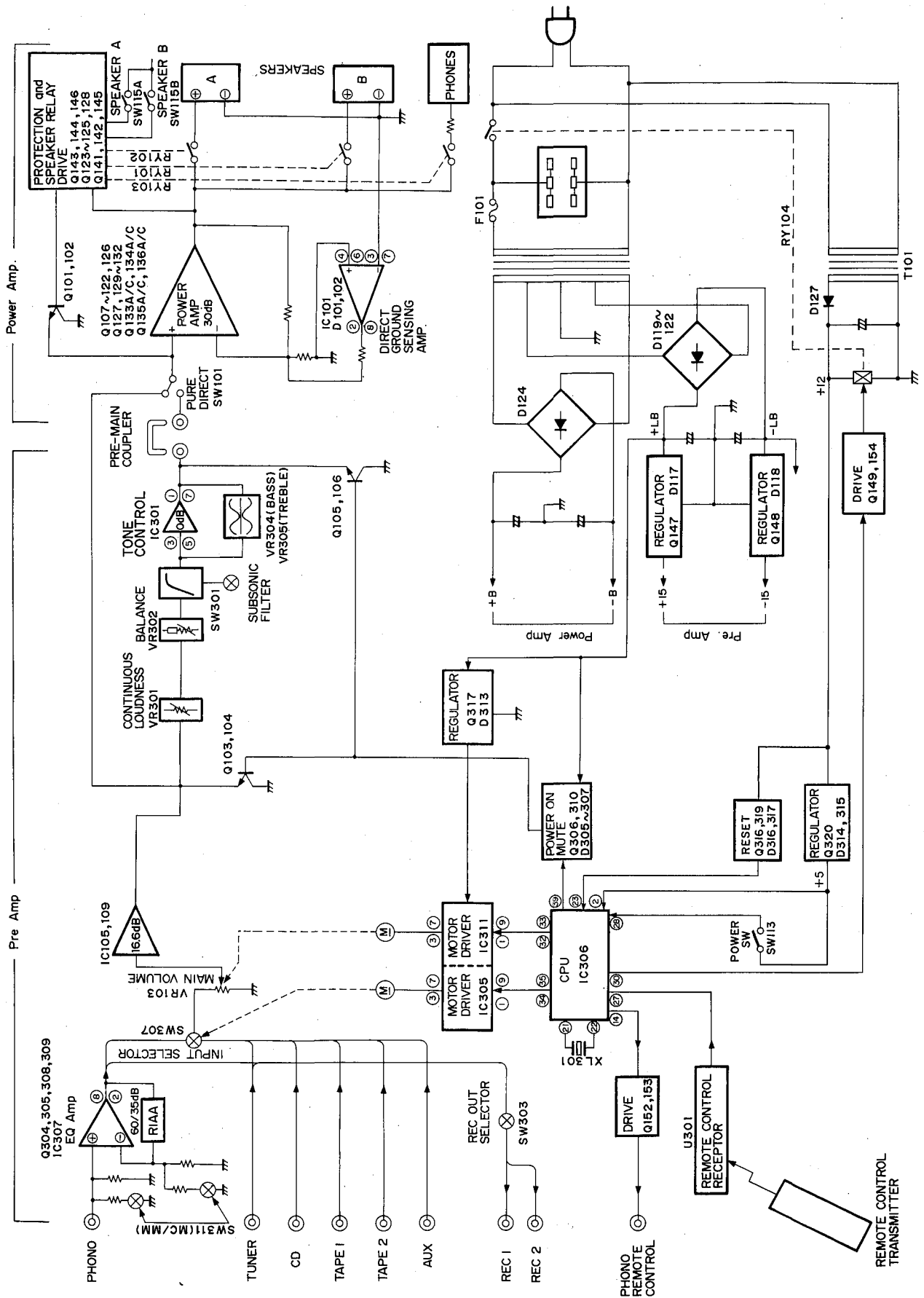

INTERNAL VIEW

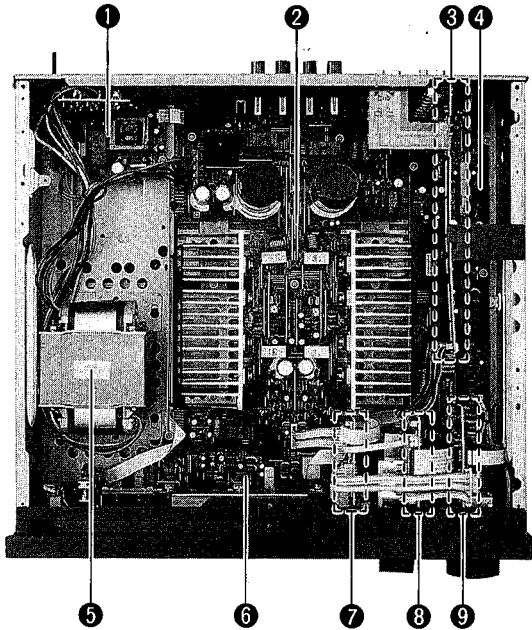

- ① MAIN P.C.B. ASS'Y (2)
- ② MAIN P.C.B. ASS'Y (1)
- ③ FUNCTION P.C.B. ASS'Y (1)
- ④ FUNCTION P.C.B. ASS'Y (4)
- ⑤ POWER TRANSFORMER
- ⑥ FUNCTION P.C.B. ASS'Y (6)
- ⑦ MAIN P.C.B. ASS'Y (4)
- ⑧ FUNCTION P.C.B. ASS'Y (3)
- ⑨ MAIN P.C.B. ASS'Y (3)

DISASSEMBLY PROCEDURES

(Remove parts in the order as numbered.)

1. Removal of Top Cover

Remove 7 screws (①) in Fig. 1.

2. Removal of Bottom Cover

- a. Remove 6 screws (②) in Fig. 1.
- b. Remove 6 screws (③) in Fig. 1.
- c. Remove 6 screws (④) in Fig. 1.

3. Removal of Front Panel

- a. Remove 7 knobs in Fig. 1.
- b. Remove 3 screws (⑤) in Fig. 1.

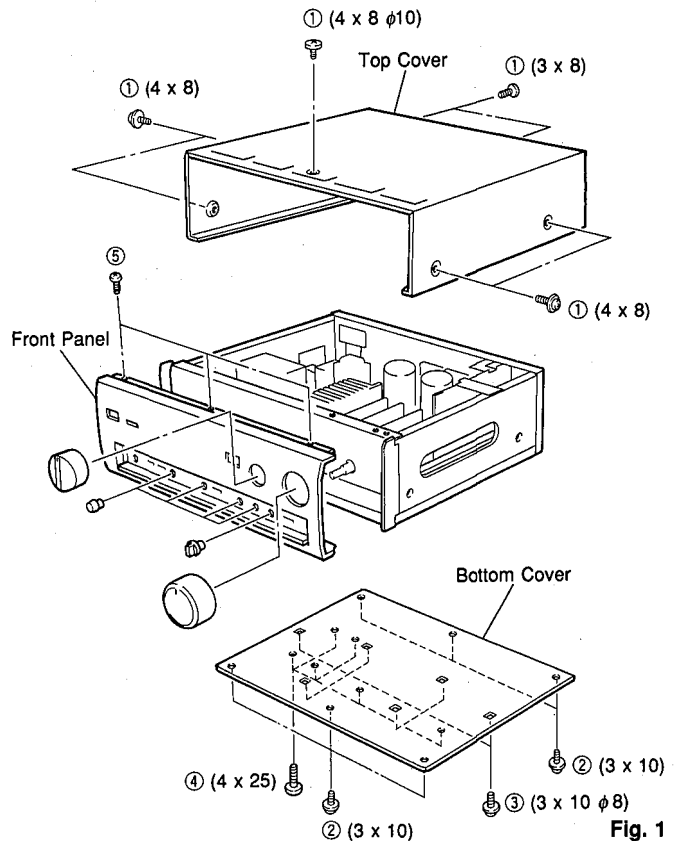

CAUTION-USE ONLY COPPER COLORED SCREWS (3X10 φ8) FOR SQUARE HOLES ON BOTTOM COVER.

←  COPPER COLORED SCREW

Fig. 1

ADJUSTMENTS

● IDLING CURRENT ADJUSTMENT

- When replacing the power and drive transistors, adjust idling current.
- After the power has been turned on, age about 10 minutes in non loaded condition.
- Adjust VR101 (Lch) and VR102 (Rch) so that the voltage across the terminals of R169 and R175 comes to 5mV~7.5mV DC.

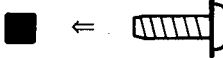
	Test Points	Adjustment Points	Rating
Lch	Across the terminals of R169 or R170 (TP1 ↔ TP2 or TP1 ↔ TP3)	VR101	5mV~7.5mV DC
Rch	Across the terminals of R175 or R176 (TP1 ↔ TP2 or TP1 ↔ TP3)	VR102	5mV~7.5mV DC

(R169, R170, R175, R176)

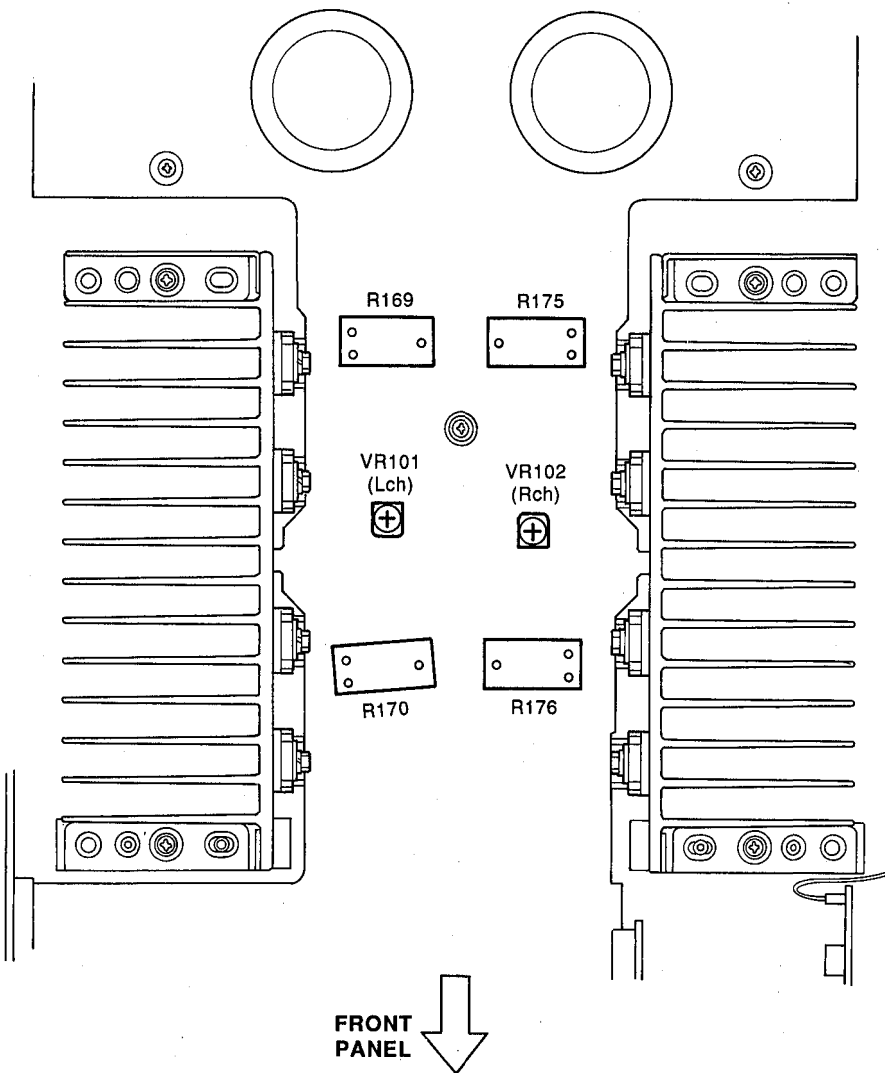
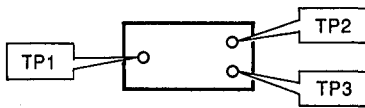

● Removal of Power Transistor

- Use a 5.5mm wrench or a small size adjustable wrench.
- Using the above tool, remove the screw fixing the Power Transistor.

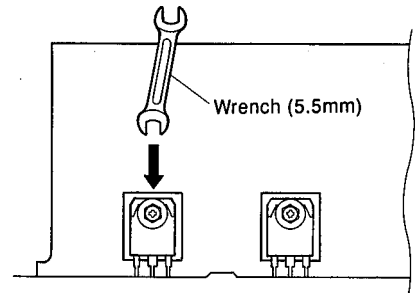

PRINTED CIRCUIT BOARD (Foil side)

Semiconductor Location

Ref. No.	Location	Ref. No.	Location	Ref. No.	Location	Ref. No.	Location
D 101	C3	D 109	B3	D 115	D3	D 121	E4
D 102	C3	D 110	B3	D 116	A5	D 122	E5
D 104	A4	D 111	E2	D 117	A5	D 123	E4
D 105	A3	D 112	F3	D 118	A5	D 124	F5
D 107	B4	D 113	F4	D 119	E5	IC101	C3
D 108	B4	D 114	D4	D 120	E4		

MAIN P. C. B. (1)

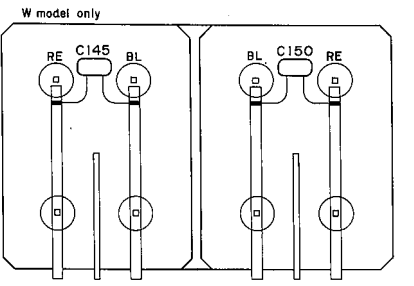
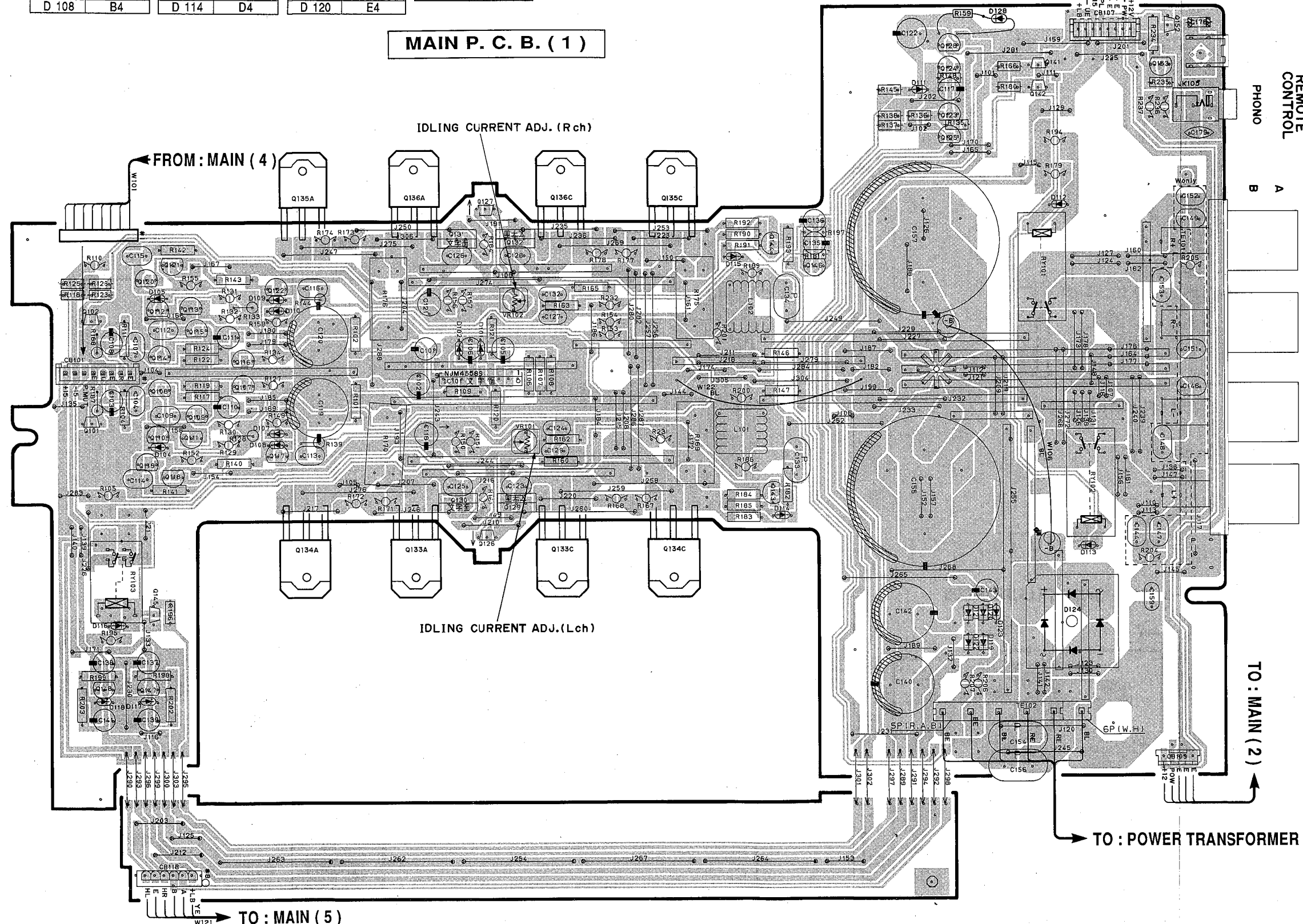

Semiconductor Location

Ref. No.	Location
Q 101	A4
Q 102	A3
Q 107	B3
Q 108	A3
Q 109	B4
Q 110	A4
Q 111	B4
Q 112	A3
Q 113	B3
Q 114	A3
Q 115	B3
Q 116	B3
Q 117	B4
Q 118	B4
Q 119	A4
Q 120	A3
Q 121	B3
Q 122	B3
Q 123	E2
Q 124	E2
Q 125	E2
Q 126	C4
Q 127	C3
Q 128	E2
Q 129	C4
Q 130	C4
Q 131	C3
Q 132	C3
Q133A	C4
Q133C	C4
Q134A	B4
Q134C	D4
Q135A	B3
Q135C	D3
Q136A	C3
Q136C	C3
Q 141	F2
Q 142	F2
Q 143	D4
Q 144	D3
Q 145	A4
Q 146	E3
Q 147	A5
Q 148	A5
Q 152	F2
Q 153	F2

1
2
3
4
5
6

PRINTED CIRCUIT BOARD (Foil side)

MAIN P. C. B. (4)

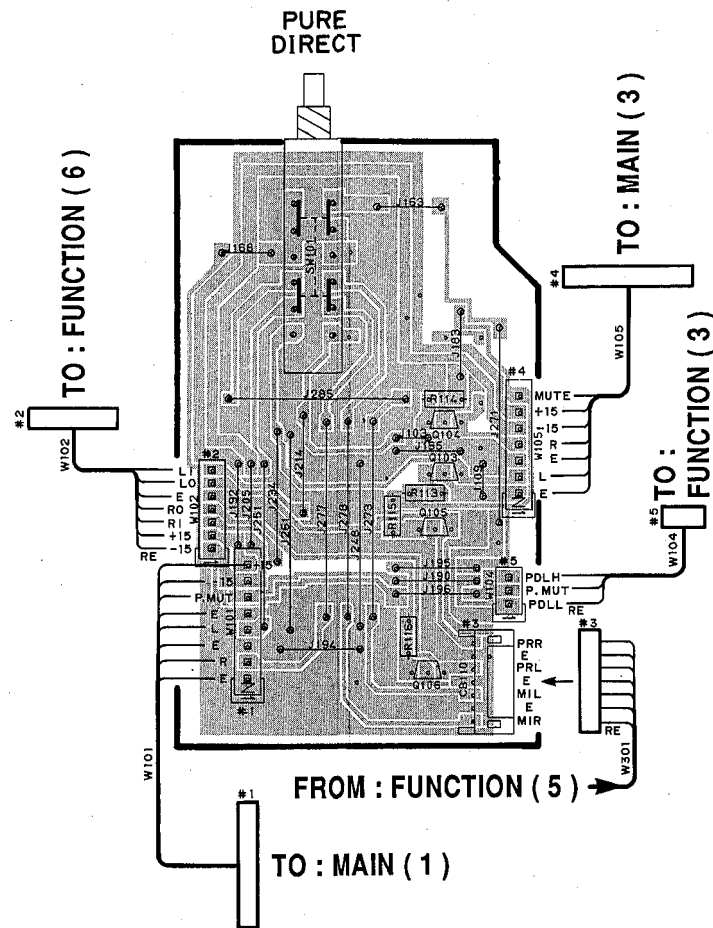

● A, B models

MAIN P. C. B. (2)

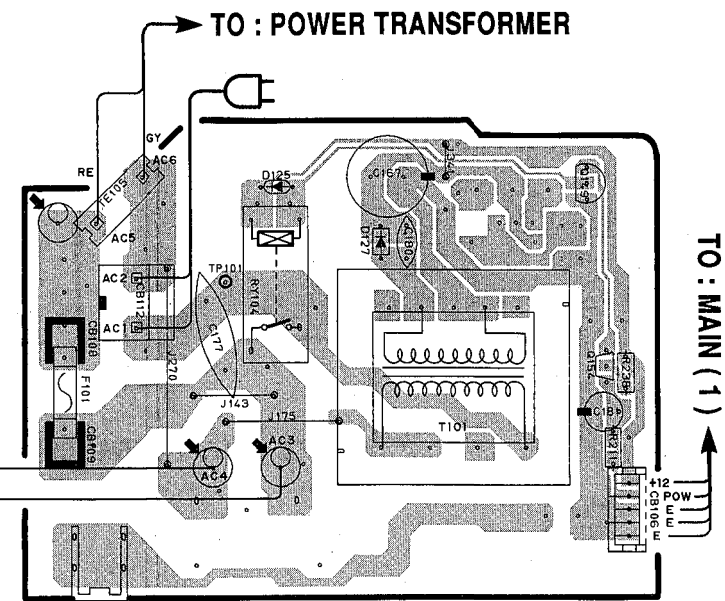
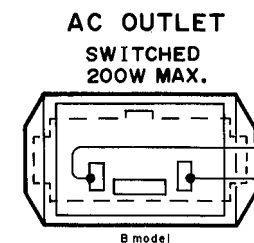
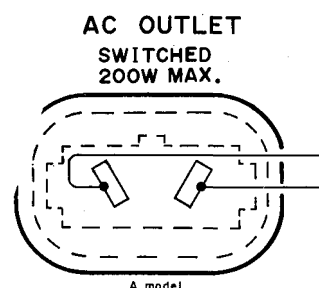

MAIN P. C. B. (8)

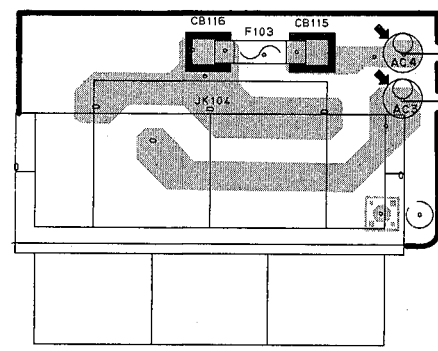

AC OUTLETS
SWITCHED
200W MAX. TOTAL

● H, W models

MAIN P. C. B. (2)

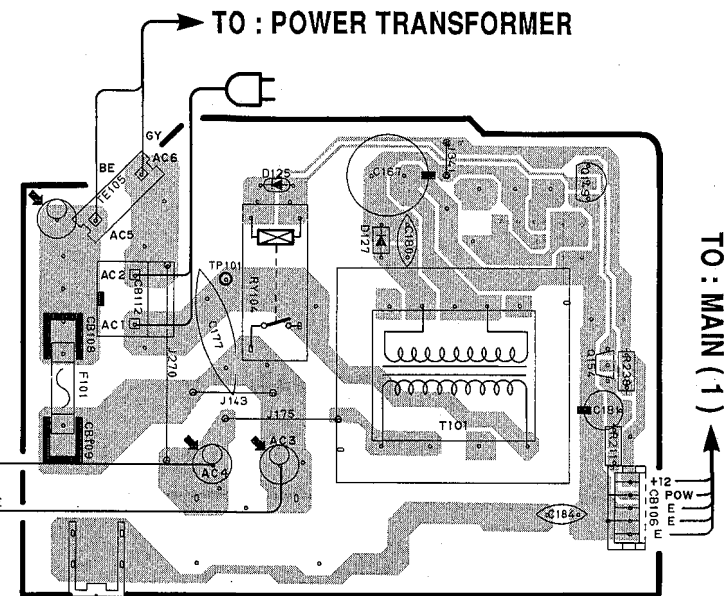

MAIN P. C. B. (6)

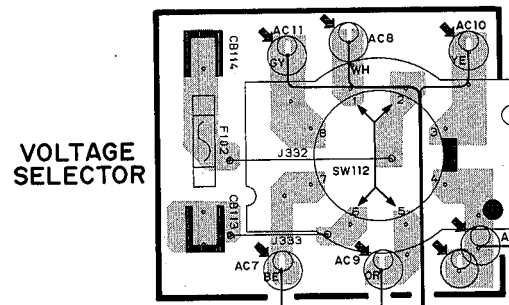

TO: POWER TRANSFORMER

● R model

MAIN P. C. B. (2)

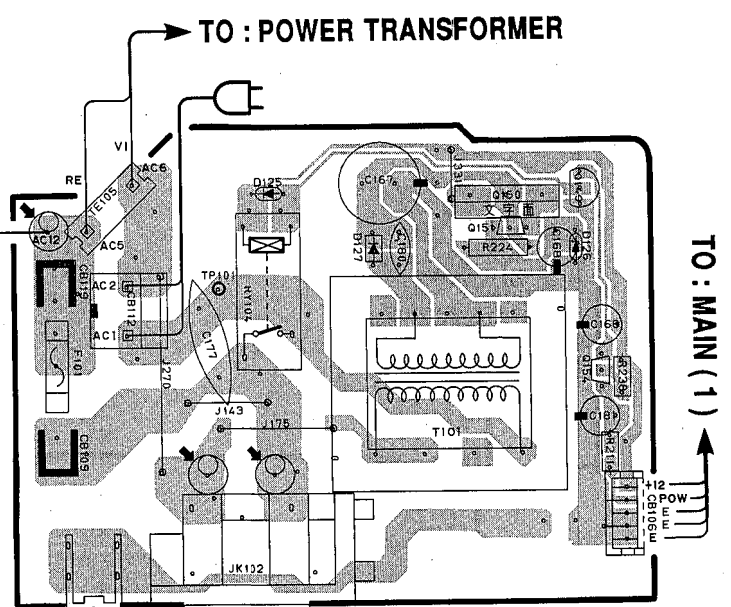

AC OUTLETS
SWITCHED
200W MAX. TOTAL

PRINTED CIRCUIT BOARD (Foil side)

MAIN P. C. B. (3)

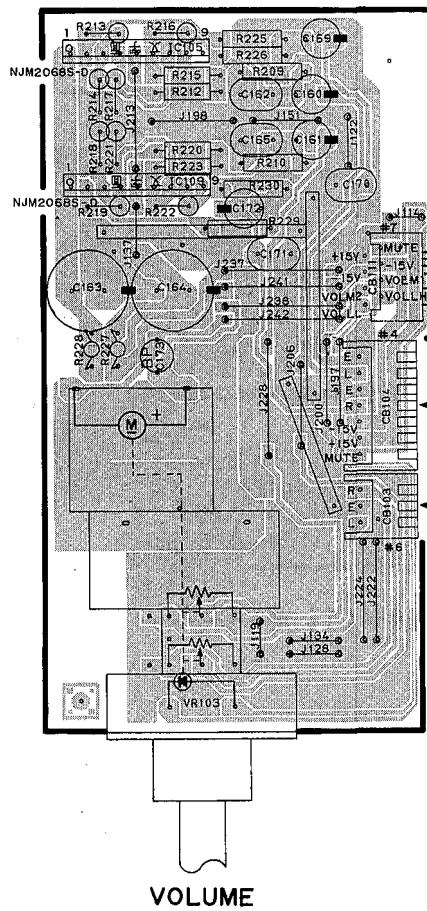

TO : FUNCTION (4)
FROM : FUNCTION (3)
FROM : MAIN (4)

VOLUME

FUNCTION P. C. B. (1)

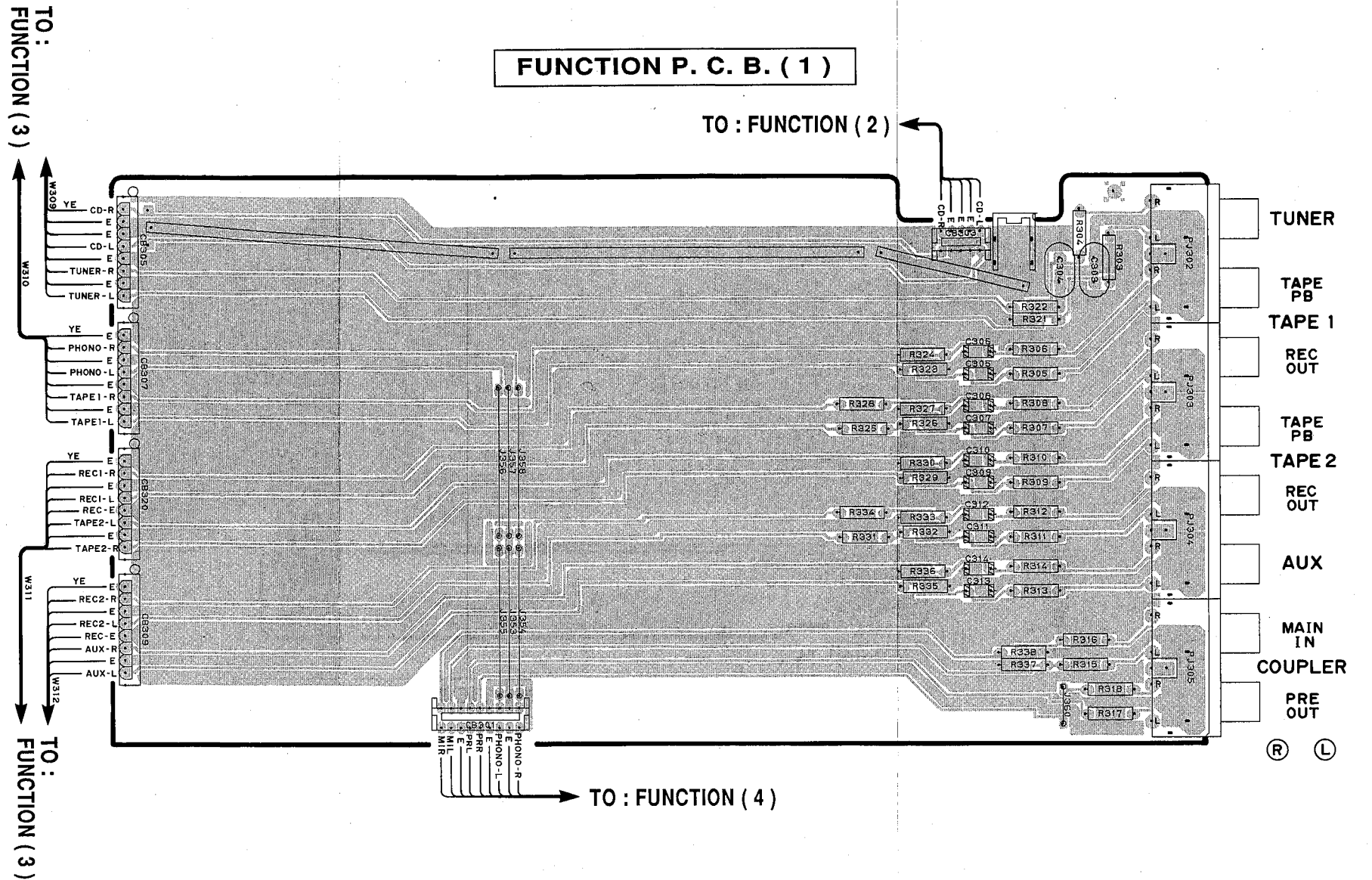

TO : FUNCTION (2)

TO : FUNCTION (4)

- TUNER
- TAPE PB
- TAPE 1
- REC OUT
- TAPE PB
- TAPE 2
- REC OUT
- AUX
- MAIN IN
- COUPLER
- PRE OUT

MAIN P. C. B. (5)

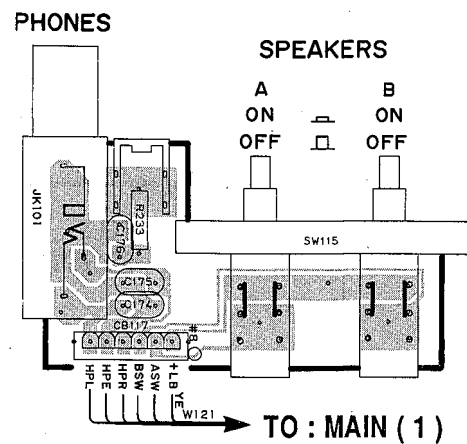

TO : MAIN (1)

MAIN P. C. B. (7)

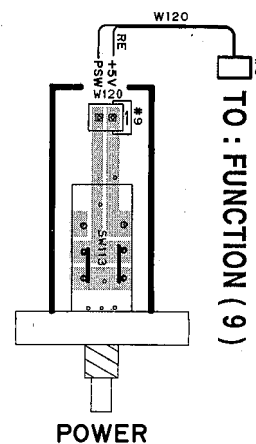

TO : FUNCTION (9)

POWER

FUNCTION P. C. B. (8)

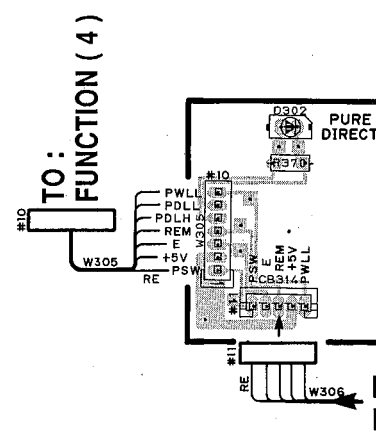

FROM : FUNCTION (9)

FUNCTION P. C. B. (2)

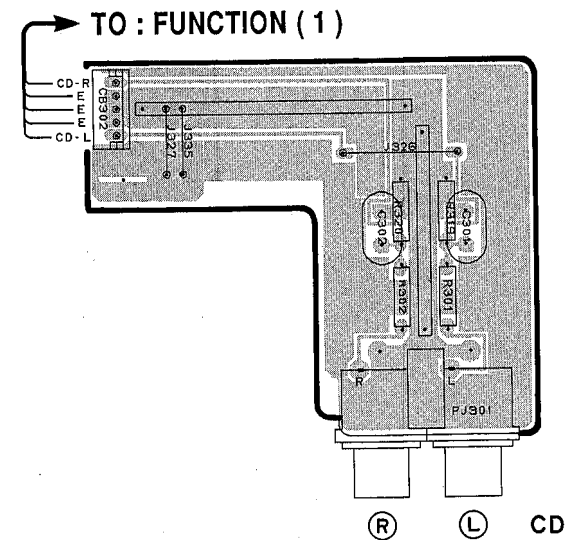

TO : FUNCTION (1)

CD

■ PRINTED CIRCUIT BOARD (Foil side)

① and ② : TEST POINT WAVEFORMS (See page 16)

● Semiconductor Location

Ref. No.	Location
D 304	D2
D 305	D2
D 306	D2
D 307	D2
D 308	F2
D 309	F2
D 310	D3
D 311	F2
D 312	D2
D 313	F3
D 314	D2
D 315	D2
D 316	C2
D 317	D2
IC301	D5
IC305	D3
IC306	C2
IC307	E2
IC311	D2
Q 301	B2
Q 302	B2
Q 303	B2
Q 304	F2
Q 305	F2
Q 306	D2
Q 307	B2
Q 308	F2
Q 309	F2
Q 310	D2
Q 312	D3
Q 315	C2
Q 316	C2
Q 317	F3
Q 318	C2
Q 319	D2
Q 320	D2

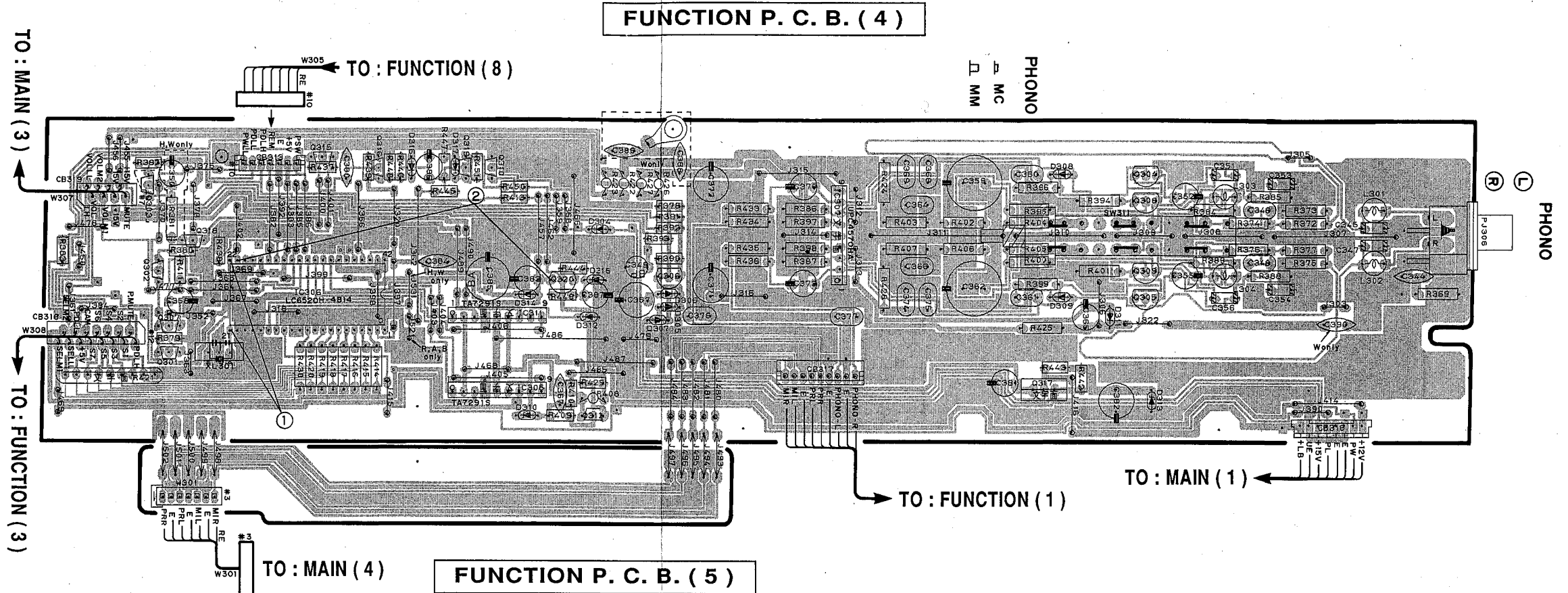

FUNCTION P. C. B. (7)

FUNCTION P. C. B. (6)

FUNCTION P. C. B. (9)

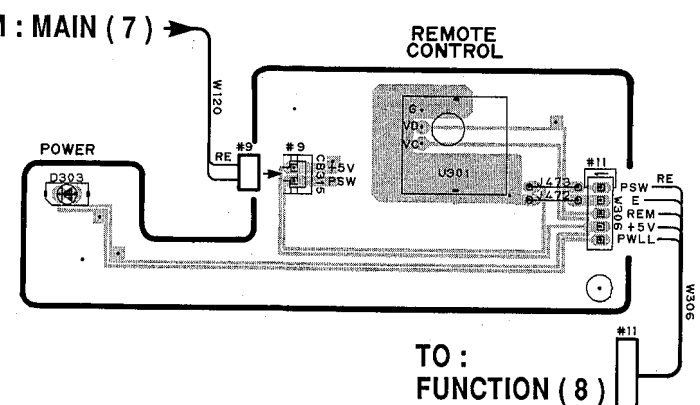
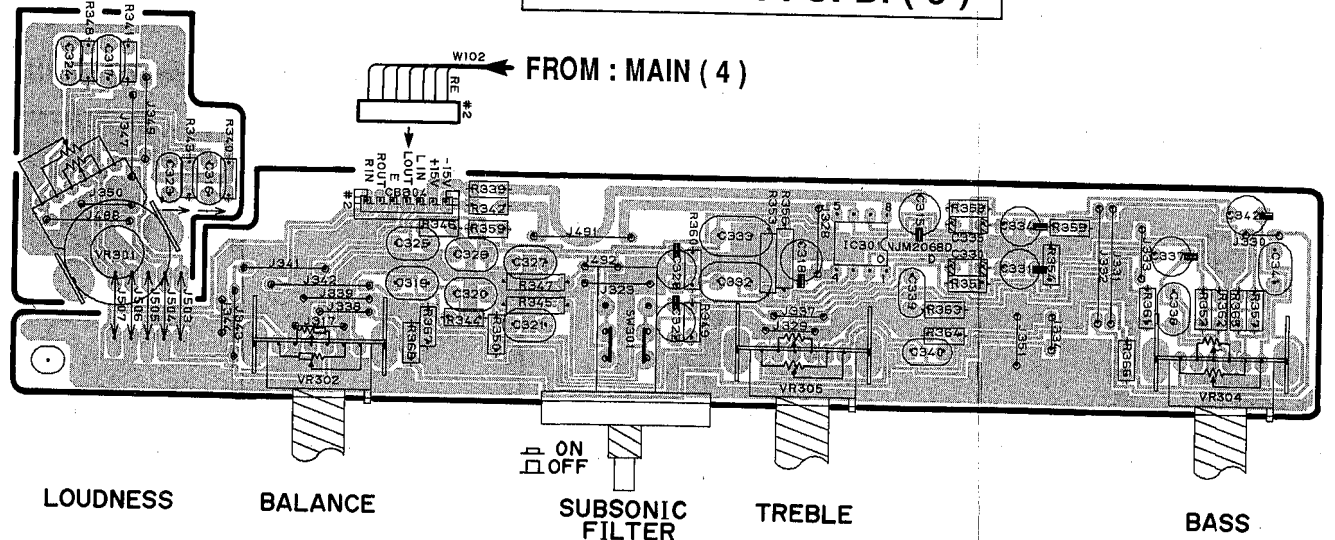

PRINTED CIRCUIT BOARD (Foil side)

FUNCTION P. C. B. (3)

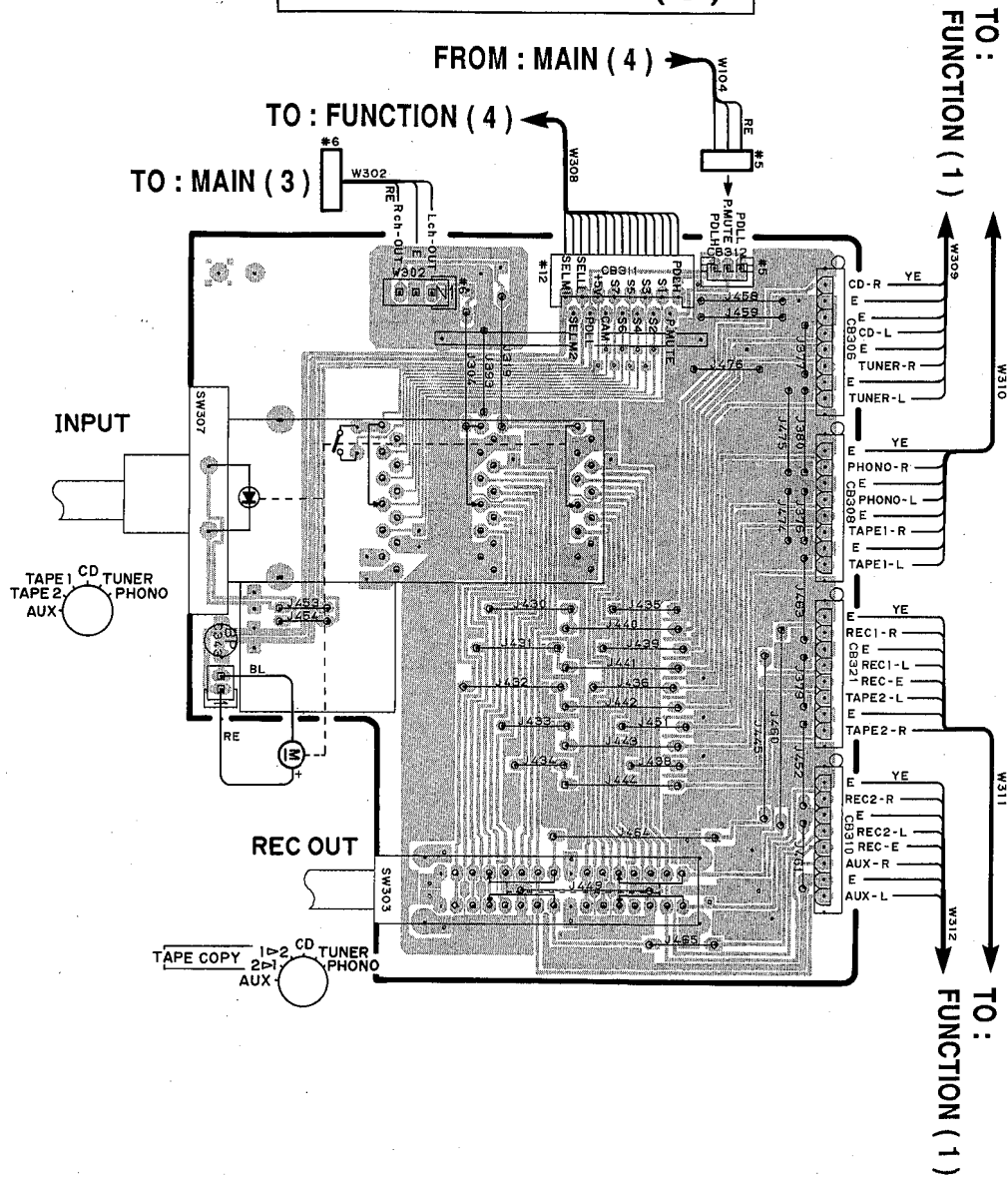

Precautions for Replacement of input Selector Switch

Make sure to perform initial setting of the input selector switch after its replacement.

● How to perform initial setting

Position the selector switch at the mid-point between the CD position and TUNER position and turn ON the POWER switch. Then the SELECTOR switch turns automatically until it finally stops at the "CD" position.

μ-COM DATA

IC306 : LC6520H
4bit μ-COM

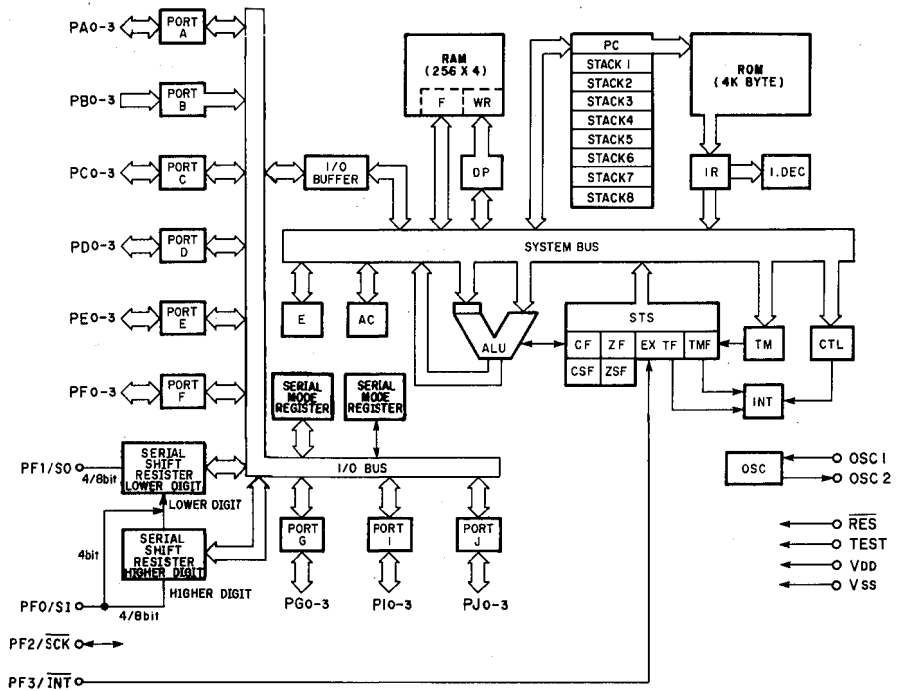
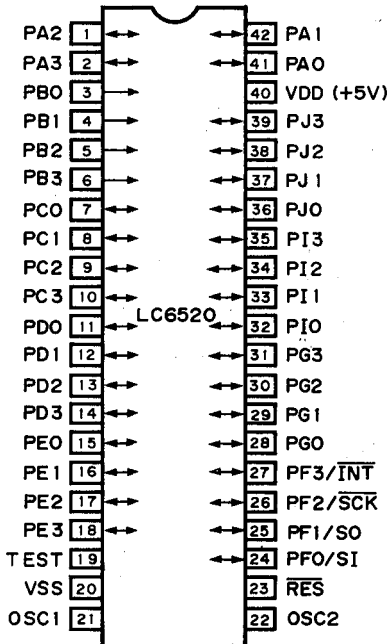

Selector Position Data (S1 to S8)

PIN NO.										FUNCTION
3	4	5	6	7	8	9	10			
1	1	0	0	0	0	0	0	0	0	PHONO
0	1	1	0	0	0	0	0	0	0	TUNER
0	0	1	1	0	0	0	0	0	0	CD
0	0	0	1	1	0	0	0	0	0	TAPE 1
0	0	0	0	1	1	0	0	0	0	TAPE 2
0	0	0	0	0	1	1	0	0	0	AUX

Table A

Pin No.	Pin. Name	I/O	Function	Pin No.	Pin. Name	I/O	Function	
1	PA2	I/O	Not used	22	OSC2	I	4MHz	
2	PA3	I/O	Not used (H)	23	RESET	I	Reset input	
3	PB0	I	Selector position data (Table A)	24	PF0	—	Not used	
4	PB1	I		S2	25	PF1	—	Not used
5	PB2	I		S3	26	PF2	I	Power Remote (H : ON, L : OFF)
6	PB3	I		S4	27	PF3	I	Remote control Data input
7	PC0	I		S5	28	PG0	I	Power SW ON/OFF
8	PC1	I		S6	29	PG1	I	Power control (H : ON, L : OFF)
9	PC2	I		S7	30	PG2	O	Power out
10	PC3	I		S8	31	PG3	O	STBY out
11	PD0	I	CAM : Cam position data	32	PI0	O	Volume control signal 2 (UP : H)	
12	PD1	I	Input (channel) set (L : 6ch set)	33	PI1	O	Volume control signal 1 (DOWN : L)	
13	PD2	I	Not used (GND)	34	PI2	O	Selector control signal 2	
14	PD3	O	PLAY/CUT (Player control)	35	PI3	O	Selector control signal 1	
15	PE0	I	Market (H : H, W models)	36	PJ0	I	Power on → A. Mute (H : ON, L : OFF)	
16	PE1	I	Power down (Back up mode)	37	PJ1	O	Audio muting LED control (Not used)	
17	PE2	—	Not used	38	PJ2	O	Audio muting control signal (Not used)	
18	PE3	I	Input selector operation mode (L:STOP, H:NONSTOP)	39	PJ3	O	Muting control signal	
19	TEST	—	GND	40	VDD	—	+5V	
20	VSS	—	GND	41	PA0	—	Not used	
21	OSC1	I	4MHz	42	PA1	—	Not used	

* When in the BACK-UP mode. (i.e., when the AC plug has been unplugged), the state before unplugging the AC plug (POWER ON/OFF) is kept in memory.

SCHEMATIC DIAGRAM

Point ① (Pin21 or Pin22 of IC306)
 V : 2V/div H : 0.1μsec/div
 DC range 1 : 1 probe

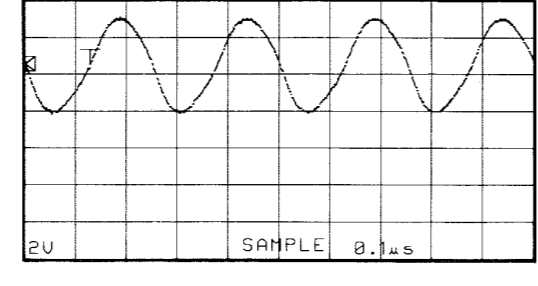

Point ② (CH1 : Emitter of Q320)
 (CH2 : Pin23 of IC306)
 V : 5V/div H : 0.5sec/div
 DC range 1 : 1 probe

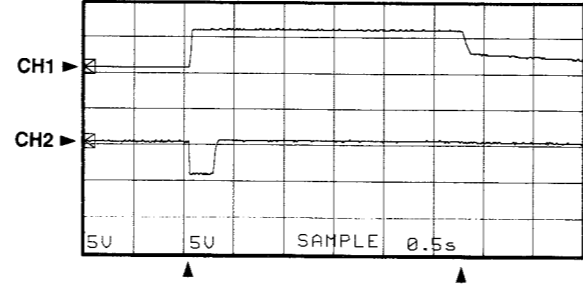

With the POWER switch turned ON, connect the power cord to the AC outlet.
 Disconnect the power cord from the AC outlet.
 (This waveform is not available by pushing the power switch ON and OFF.)

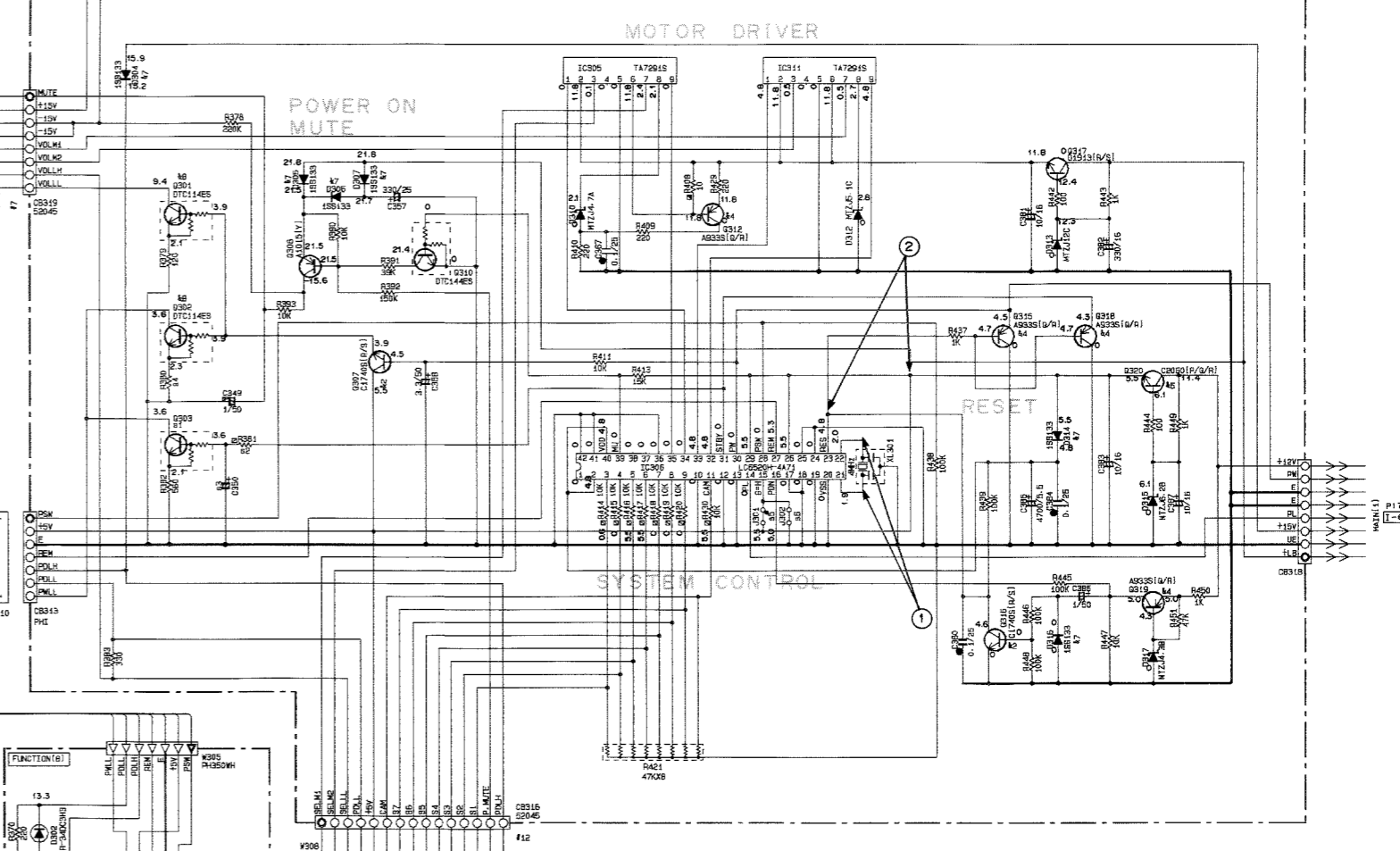
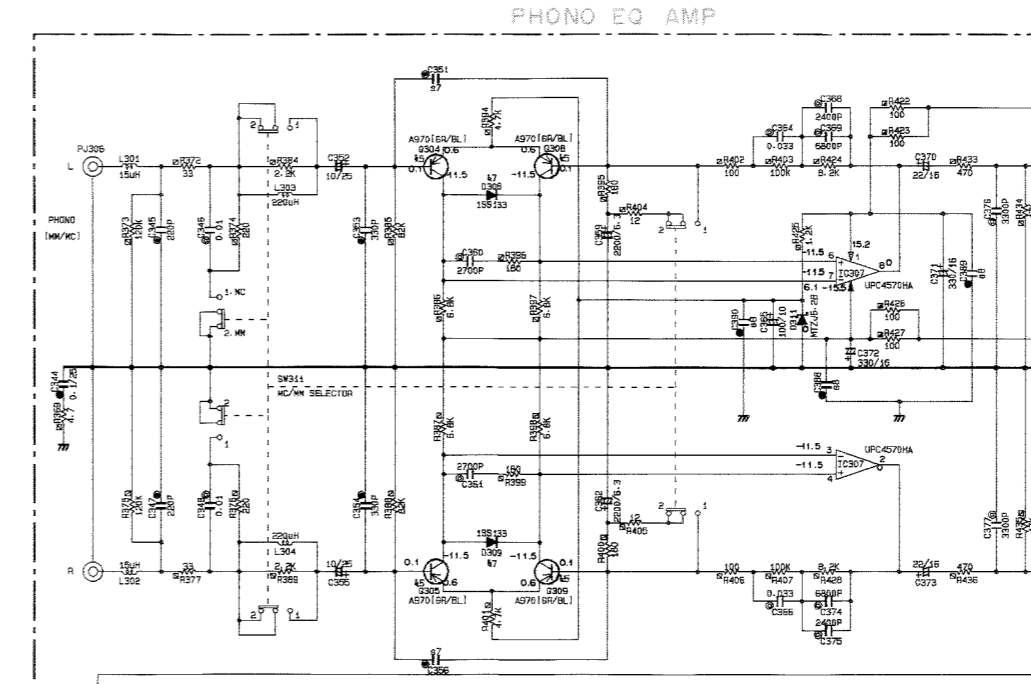
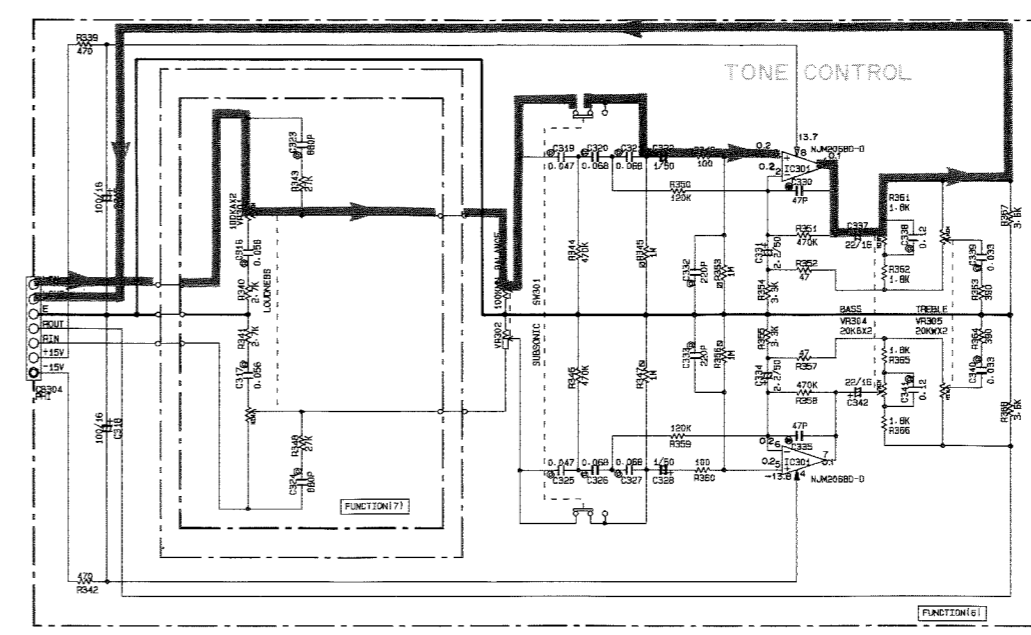
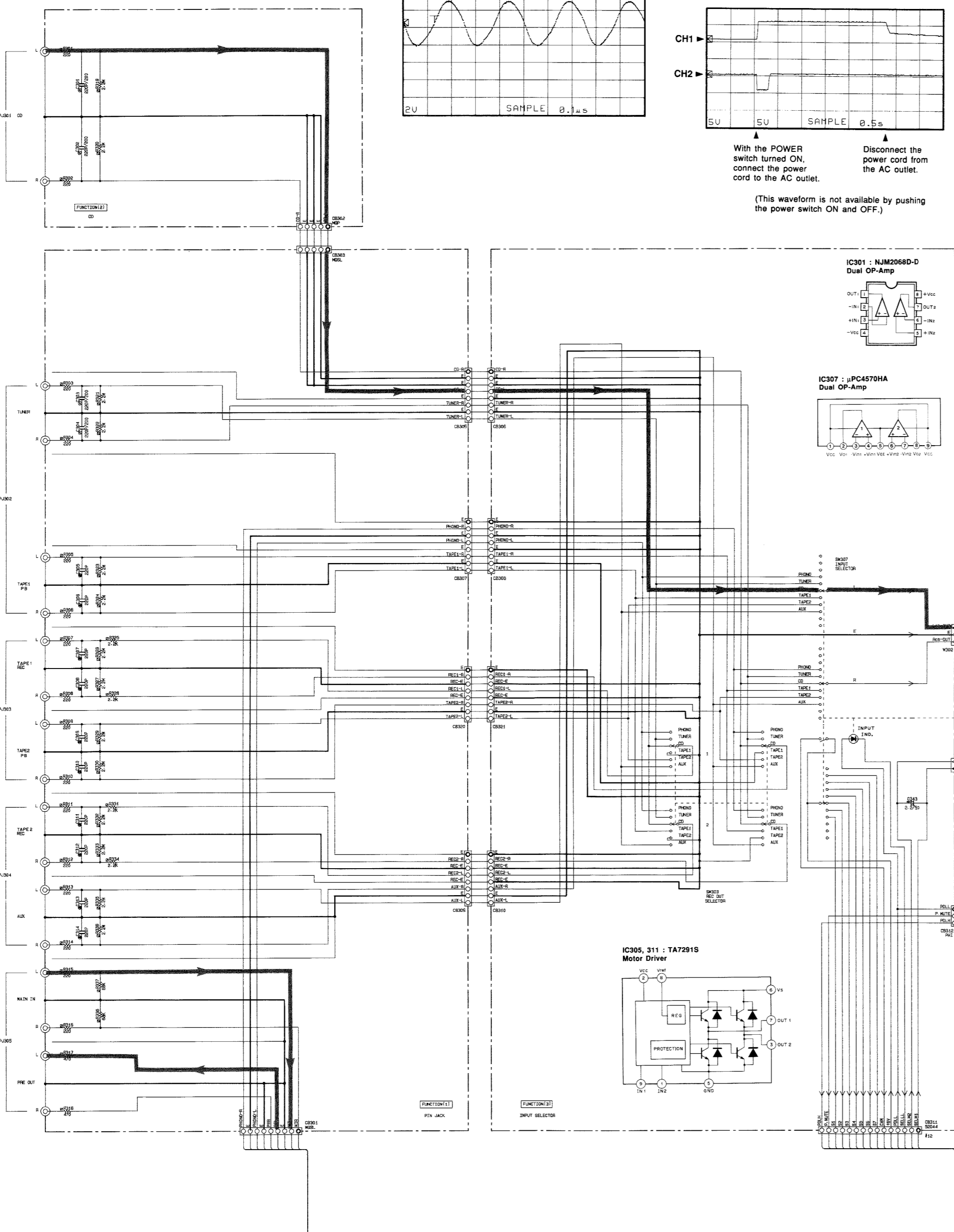

Interchangeable Parts at Manufacture Stage

Part No.	Reference Parts Number	Parts Name
41		
42	2006-338	28C1740S (R, S)
43	U301	2SA1015 (Y)
44	0312-315-318-319	2SA1015 (Y)
45	0304-305-306-309	2SC2603 (E, F)
46	0300	2SC2603 (E, F)
47	0304-305-314-316	2SC2603 (E, F)
48	0201-202	2SC2603 (E, F)

PIN CONNECTION DIAGRAM OF TRANSISTORS, DIODES AND ICs.

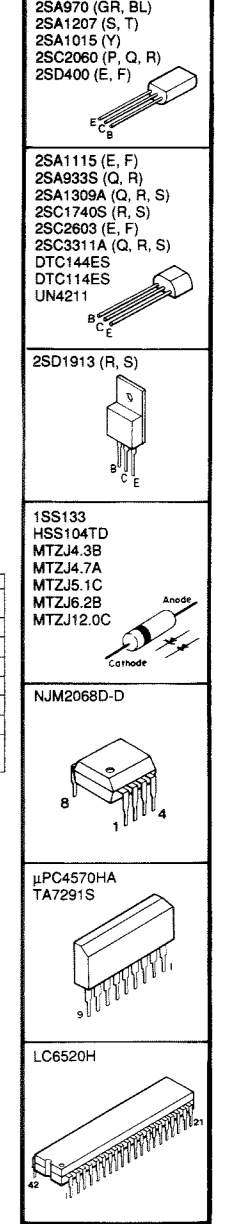

FUNCTION

FUNCTION	S.A.B.	H	W
41	0003	X	DT114ES on UM211
42	0201	X	DT114ES on UM211
43	0200	X	DT114ES on UM211
44	0300	X	DT114ES on UM211
45	0301	X	DT114ES on UM211
46	0301	X	DT114ES on UM211
47	0301-030	X	DT114ES on UM211
48	0301-030	X	DT114ES on UM211
49	0301-030	X	DT114ES on UM211

Selector Position Data (INPUT)

IC306 PIN NO.	FUNCTION
3	PHONO
4	TUNER
5	CD
6	TAPE 1
7	TAPE 2
8	AUX

- Conditions**
- FUNCTION → CD
 - REC OUT → CD
 - PURE DIRECT → ON
 - SPEAKERS → A : ON
B : OFF
 - VOLUME → minimum (∞)

* All voltage are measured with a 10MΩ V DC electric volt meter.
 * Schematic diagram is subject to change without notice.

REMARKS	PARTS NAME	REMARKS	PARTS NAME
NO MARK	ELECTROLYTIC CAPACITOR	NO MARK	CARBON FILM RESISTOR 1/4W
⊗	TANTALUM CAPACITOR	⊗	CARBON FILM RESISTOR 1/2W
NR	CERAMIC CAPACITOR	Δ	METAL OXIDE FILM RESISTOR
⊖	AXIAL LEAD CERAMIC CAPACITOR	□	METAL FILM RESISTOR
○	POLYESTER FILM CAPACITOR	▣	FINE PITCH CARBON FILM RESISTOR
⊙	POLYSTYRENE FILM CAPACITOR	⊖	CEMENT MOLDED RESISTOR
⊕	MICA CAPACITOR	⊖	SEMIVARIABLE RESISTOR
⊖	POLYPROPYLENE FILM CAPACITOR	⊖	ICP RESISTOR
⊖	SEMICONDUCTIVE CERAMIC CAPACITOR		

NOTICE

(J)..... Japanese model
 (U)..... U.S.A. model
 (C)..... Canadian model
 (A)..... Australian model
 (G)..... European model
 (B)..... British model
 (P)..... German model
 (S)..... PP model

SCHEMATIC DIAGRAM

CAPACITOR

REMARKS	PARTS NAME
NO MARK	ELECTROLYTIC CAPACITOR
⊖	TANTALUM CAPACITOR
⊖	METAL CERAMIC CAPACITOR
⊖	AXIAL LEAD CERAMIC CAPACITOR
⊖	POLYESTER FILM CAPACITOR
⊖	POLYSTYRENE FILM CAPACITOR
⊖	MICA CAPACITOR
⊖	POLYPROPYLENE FILM CAPACITOR
⊖	SEMICONDUCTIVE CERAMIC CAPACITOR

RESISTOR

REMARKS	PARTS NAME
NO MARK	CARBON FILM RESISTOR (1/4W)
⊖	CARBON FILM RESISTOR (1/2W)
⊖	METAL OXIDE FILM RESISTOR
⊖	METAL FILM RESISTOR
⊖	METAL PLATE RESISTOR
⊖	THICK FROOF CARBON FILM RESISTOR
⊖	CEMENT MOUNTED RESISTOR
⊖	SEMI VARIABLE RESISTOR
⊖	CHIP RESISTOR

NOTICE
 (J)..... Japanese model
 (U)..... U.S.A model
 (C)..... Canadian model
 (A)..... Australian model
 (G)..... European model
 (B)..... British model
 (R)..... General model
 (P)..... P.P. model

R	A-B	H	W
R1	F10P	4.5A250V	X
R2	CB113-114	VP20850	X
R3	BM112	VAB180	X
R4	F101	10A250V	S T4.0A250V S T4.0A250V S T4.0A250V
R5	C184	X	X
R6	JK102	V13780	X
R7			
R8			
R9	TE102	LA00234	LA00234
R10	C145-146-150-153	X	X

R	A-B	H	W
R11	C144-147-149-152	X	X
R12	C145-151	X	X
R13	R204-205	X	X
R14	TE101	VL82010	VL82010
R15			
R16	C185-188	10/16	X
R17	R150	287710/PV1	X
R18	R151	287710/PV1	X
R19	R126	VT133M	X
R20			

R	A-B	H	W
R21	R204	18K	X
R22	C187	470/53	470/25
R23	T101	KC082	KC084
R24	JK104	X	X
R25	F103	X	X
R26	CB115-118	X	X
R27			
R28			
R29	J341	X	X
R30	JK113	X	X
R31	C170-171	220P/200	220P/200
R32	R41-142	330	330

Interchangeable Parts at Manufacture-Stage

Mark	Reference Data Number	Part's Name
41	IC101	NUM4558S AN6551 BA715
42	RY101-103	RY400-07M1-11 65P-3220P
43	D107-108-114-115-145	25A1207(S,T) 25A1207(S,T) 25C1745(S,T) 25C2061(S,T) 25C3314(S,T/S) 25C3314(S,T/S)
44	D154	25C1745(S,T) 25C2061(S,T) 25C3314(S,T/S) 25C3314(S,T/S)
45	G128-143-144-148	25C2041(S,T/S) 25C2041(S,T/S)

46	D101-106	25D115(S,T) 25C2076(S,T)
47	D101-104-105-107-111	15R153 HSS104TD
48	D114-115-123	MA185 15S146

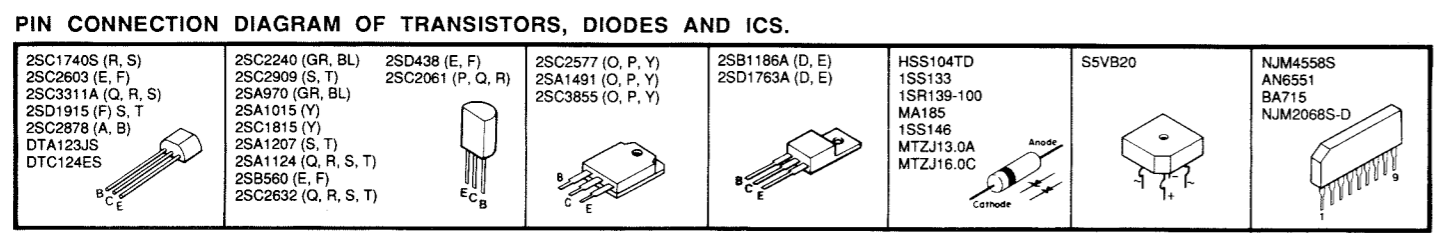
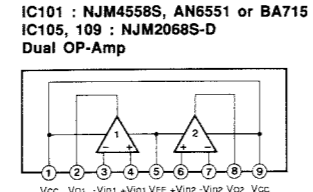
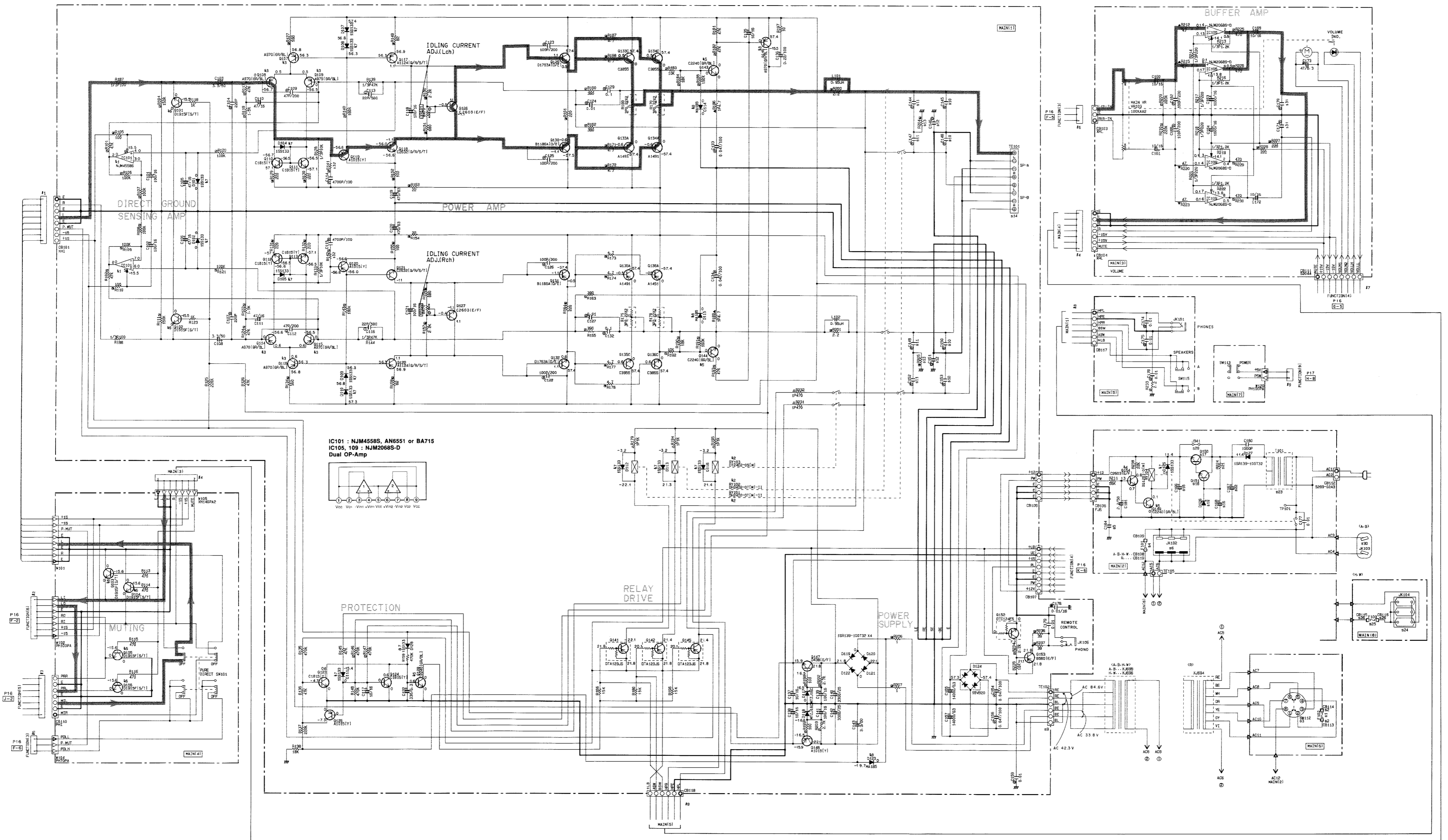

* All voltage are measured with a 10MΩ/V DC electric volt meter.
 * Schematic diagram is subject to change without notice.

PARTS LIST

■ ELECTRICAL PARTS

■ WARNING

- Carbon resistors (1/6W or 1/4W) are not included in the ELECTRICAL PARTS List. For the parts No. of the carbon resistors, refer to last page.

ABBREVIATIONS IN THIS LIST ARE AS FOLLOWS :

C.A.EL.CHP	: CHIP ALUMI. ELECTROLYTIC CAP	L.EMIT	: LIGHT EMITTING MODULE
C.CE	: CERAMIC CAP	LED.DSPLY	: LED DISPLAY
C.CE.ARRAY	: CERAMIC CAP ARRAY	LED.INFRD	: LED, INFRARED
C.CE.CHP	: CHIP CERAMIC CAP	MODUL.RF	: MODULATOR, RF
C.CE.ML	: MULTILAYER CERAMIC CAP	PHOT.CPL	: PHOTO COUPLER
C.CE.M.CHP	: CHIP MULTILAYER CERAMIC CAP	PHOT.INTR	: PHOTO INTERRUPTER
C.CE.SAFETY	: RECOGNIZED CERAMIC CAP	PHOT.RFLCT	: PHOTO REFLECTOR
C.CE.TUBLR	: CERAMIC TUBULAR CAP	PIN.TEST	: PIN, TEST POINT
C.CE.SMI	: SEMI CONDUCTIVE CERAMIC CAP	PLST.RIVET	: PLASTIC RIVET
C.EL	: ELECTROLYTIC CAP	R.ARRAY	: RESISTOR ARRAY
C.MICA	: MICA CAP	R.CAR	: CARBON RESISTOR
C.ML.FLM	: MULTILAYER FILM CAP	R.CAR.CHP	: CHIP RESISTOR
C.MP	: METALLIZED PAPER CAP	R.CAR.FP	: FLAME PROOF CARBON RESISTOR
C.MYLAR	: MYLAR FILM CAP	R.FUS	: FUSABLE RESISTOR
C.MYLAR.ML	: MULTILAYER MYLAR FILM CAP	R.MTL.CHP	: CHIP METAL FILM RESISTOR
C.PAPER	: PAPER CAPACITOR	R.MTL.FLM	: METAL FILM RESISTOR
C.PLS	: POLYSTYRENE FILM CAP	R.MTL.OXD	: METAL OXIDE FILM RESISTOR
C.POL	: POLYESTER FILM CAP	R.MTL.PLAT	: METAL PLATE RESISTOR
C.POLY	: POLYETHYLENE FILM CAP	RSNR.CE	: CERAMIC RESONATOR
C.PP	: POLYPROPYLENE FILM CAP	RSNR.CRYS	: CRYSTAL RESONATOR
C.TNTL	: TANTALUM CAP	R.TW.CEM	: TWIN CEMENT FIXED RESISTOR
C.TNTL.CHP	: CHIP TANTALUM CAP	R.WW	: WIRE WOUND RESISTOR
C.TRIM	: TRIMMER CAP	SCR.BND.HD	: BIND HEAD B-TITE SCREW
CN	: CONNECTOR	SCR.BW.HD	: BW HEAD TAPPING SCREW
CN.BS.PIN	: CONNECTOR, BASE PIN	SCR.CUP	: CUP TITE SCREW
CN.CANNON	: CONNECTOR, CANNON	SCR.TERM	: SCREW TERMINAL
CN.DIN	: CONNECTOR, DIN	SCR.TR	: SCREW, TRANSISTOR
CN.FLAT	: CONNECTOR, FLAT CABLE	SUPRT.PCB	: SUPPORT, P.C.B.
CN.POST	: CONNECTOR, BASE POST	SURG.PRTCT	: SURGE PROTECTOR
COIL.MX.AM	: COIL, AM MIX	SW.TACT	: TACT SWITCH
COIL.AT.FM	: COIL, FM ANTENNA	SW.LEAF	: LEAF SWITCH
COIL.DT.FM	: COIL, FM DETECT	SW.LEVER	: LEVER SWITCH
COIL.MX.FM	: COIL, FM MIX	SW.MICRO	: MICRO SWITCH
COIL.OUTPT	: OUTPUT COIL	SW.PUSH	: PUSH SWITCH
DIOD.ARRAY	: DIODE ARRAY	SW.RT.ENC	: ROTARY ENCODER
DIODE.BRG	: DIODE BRIDGE	SW.RT.MTR	: ROTARY SWITCH WITH MOTOR
DIODE.CHP	: CHIP DIODE	SW.RT	: ROTARY SWITCH
DIODE.VAR	: VARACTOR DIODE	SW.SLIDE	: SLIDE SWITCH
DIOD.Z.CHP	: CHIP ZENER DIODE	TERM.SP	: SPEAKER TERMINAL
DIODE.ZENR	: ZENER DIODE	TERM.WRAP	: WRAPPING TERMINAL
DSCR.CE	: CERAMIC DISCRIMINATOR	THRMST.CHP	: CHIP THERMISTOR
FER.BEAD	: FERRITE BEADS	TR.CHP	: CHIP TRANSISTOR
FER.CORE	: FERRITE CORE	TR.DGT	: DIGITAL TRANSISTOR
FET.CHP	: CHIP FET	TR.DGT.CHP	: CHIP DIGITAL TRANSISTOR
FL.DSPLY	: FLUORESCENT DISPLAY	TRANS	: TRANSFORMER
FLTR.CE	: CERAMIC FILTER	TRANS.PULS	: PULSE TRANSFORMER
FLTR.COMB	: COMB FILTER MODULE	TRANS.PWR	: POWER TRANSFORMER ASS'y
FLTR.LC.RF	: LC FILTER ,EMI	TUNER.AM	: TUNER PACK, AM
GND.MTL	: GROUND PLATE	TUNER.FM	: TUNER PACK, FM
GND.TERM	: GROUND TERMINAL	TUNER.PK	: FRONT-END TUNER PACK
HOLDER.FUS	: FUSE HOLDER	VR	: ROTARY POTENTIOMETER
IC.PRTCT	: IC PROTECTOR	VR.MTR	: POTENTIOMETER WITH MOTOR
JUMPER.CN	: JUMPER CONNECTOR	VR.SW	: POTENTIOMETER WITH ROTARY SW
JUMPER.TST	: JUMPER, TEST POINT	VR.SLIDE	: SLIDE POTENTIOMETER
L.DTCT	: LIGHT DETECTING MODULE	VR.TRIM	: TRIMMER POTENTIOMETER

Note) Those parts marked with "#" are not included in the P.C.B. ass'y.

MAIN P. C. B.

Schm Ref.	PART NO.	Description		
*	VQ335400	P.C.B.	MAIN (R)	
*	VQ335500	P.C.B.	MAIN (AB)	
*	VQ335600	P.C.B.	MAIN (H)	
*	VQ335700	P.C.B.	MAIN (W)	
CB101	VL845200	CN	XH	8P TE
CB103	LB919030	CN.BS.PIN	XH L-TYPE	3P SE
CB104	LB919070	CN.BS.PIN	XH	7P SE
CB105	VP768100	CN.BS.PIN	FJ	5P TE
CB108	VP206500	HOLDER.FUS	EYF-52BC (ABHW)	
CB109	VP206500	HOLDER.FUS	EYF-52BC	
CB110	VD005000	CN.BS.PIN	PH i-TYPE	7P TE
CB111	VP682300	CN	52045	8P SE
CB112	VE225700	CN.BS.PIN	2P	P=7.5
CB113	VP206500	HOLDER.FUS	EYF-52BC (R)	
CB114	VP206500	HOLDER.FUS	EYF-52BC (R)	
CB115	VP206500	HOLDER.FUS	EYF-52BC (HW)	
CB116	VP206500	HOLDER.FUS	EYF-52BC (HW)	
CB117	VA725600	HOLDER	6P	
CB118	VA725600	HOLDER	6P	
CB119	VP206500	HOLDER.FUS	EYF-52BC (R)	
C101	VG288900	C.EL	100uF	25V
C102	VG288900	C.EL	100uF	25V
C103	VG290700	C.EL	3.3uF	50V
C104	VK984200	C.MYLAR	220pF	50V
C105	VE742600	C.EL	47uF	25V
C106	VE742600	C.EL	47uF	25V
C107	VK984200	C.MYLAR	220pF	50V
C108	VG290700	C.EL	3.3uF	50V
C109	VK533800	C.PP	47pF	200V
C110	Vi532800	C.EL	47uF	16V
C111	Vi532800	C.EL	47uF	16V
C112	VK533800	C.PP	47pF	200V
C113	FU351220	C.MICA	22pF	500V
C114	UT453470	C.PP	4700pF	100V
C115	UT453470	C.PP	4700pF	100V
C116	FU351220	C.MICA	22pF	500V
C117	VG290900	C.EL	10uF	50V
C118	VG288900	C.EL	100uF	25V
C119	VF807200	C.EL	470uF	63V
C120	VF807200	C.EL	470uF	63V
C121	VG288900	C.EL	100uF	25V
C122	VE016700	C.EL	330uF	6.3V
C123	VK533900	C.PP	100pF	200V
C124	VE324800	C.MYLAR.ML	0.01uF	50V
C125	VK533900	C.PP	100pF	200V
C126	VK533900	C.PP	100pF	200V
C127	VE324800	C.MYLAR.ML	0.01uF	50V
C128	VK533900	C.PP	100pF	200V
C129	VE326000	C.MYLAR.ML	0.1uF	50V
C132	VE326000	C.MYLAR.ML	0.1uF	50V
C133	VK534400	C.PP	0.047uF	100V
C134	VK534400	C.PP	0.047uF	100V
C135	VG290900	C.EL	10uF	50V

* New Parts

Schm Ref.	PART NO.	Description		
C136	UJ895220	C.EL	0.22uF	100V
C137	VG290900	C.EL	10uF	50V
C138	VG290900	C.EL	10uF	50V
C139	VG288900	C.EL	100uF	25V
C140	VG289400	C.EL	3300uF	25V
C141	VG288900	C.EL	100uF	25V
C142	VG289400	C.EL	3300uF	25V
C143	VG290700	C.EL	3.3uF	50V
C144	UT453390	C.PP	3900pF	100V (W)
C145	VM707200	C.PP	0.012uF	100V (W)
C146	VK534200	C.PP	0.022uF	100V (W)
C147	UT453390	C.PP	3900pF	100V (W)
C148	VM707200	C.PP	0.012uF	100V (W)
C149	UT453390	C.PP	3900pF	100V (W)
C150	VM707200	C.PP	0.012uF	100V (W)
C151	VK534200	C.PP	0.022uF	100V (W)
C152	UT453390	C.PP	3900pF	100V (W)
C153	VM707200	C.PP	0.012uF	100V (W)
C154	VK534400	C.PP	0.047uF	100V
C155	VL715300	C.EL	14000uF	63V
C156	VK534400	C.PP	0.047uF	100V
C157	VL715300	C.EL	14000uF	63V
* C159	Vi716700	C.MYLAR	0.01uF	50V
C160	VQ082700	C.EL	10uF	16V
C161	VQ082700	C.EL	10uF	16V
C162	VK533900	C.PP	100pF	200V
C163	VG779100	C.EL	1000uF	16V
C164	VG779100	C.EL	1000uF	16V
C165	VK533900	C.PP	100pF	200V
C166	VG290900	C.EL	10uF	50V (R)
C167	VG289200	C.EL	470uF	25V (ABHW)
C167	VK347900	C.EL	470uF	63V (R)
C168	VG290900	C.EL	10uF	50V (R)
C169	VG290900	C.EL	10uF	50V
C170	VK534000	C.PP	220pF	200V (RABH)
C170	VL883800	C.PP	2200pF	100V (W)
C171	VK534000	C.PP	220pF	200V (RABH)
C171	VL883800	C.PP	2200pF	100V (W)
C172	VG290900	C.EL	10uF	50V
C173	VN508100	C.EL	47uF	6.3V
C174	UA654100	C.MYLAR	0.01uF	50V
C175	UA654100	C.MYLAR	0.01uF	50V
C176	UA654100	C.MYLAR	0.01uF	50V
C177	Fi384100	C.CE.SAFTY	0.01uF	400V
C178	VF467300	C.CE.TUBLR	0.01uF	16V
C179	UG444100	C.CE	0.01uF	50V
C180	FG213100	C.CE	1000pF	50V
C181	VJ839200	C.EL	2.2uF	50V
C184	FZ005880	C.CE.ML	0.1uF	25V (HW)
D101	iF004600	DIODE	1SS133	
D102	iF004600	DIODE	1SS133	
D104	iF004600	DIODE	1SS133	
D105	iF004600	DIODE	1SS133	

* New Parts

MAIN P. C. B.

Schm Ref.	PART NO.	Description	
D107	iF004600	DIODE	1SS133
D108	iF004600	DIODE	1SS133
D109	iF004600	DIODE	1SS133
D110	iF004600	DIODE	1SS133
D111	iF004600	DIODE	1SS133
D112	iF004600	DIODE	1SS133
D113	iF004600	DIODE	1SS133
D114	VC398400	DIODE	MA185
D115	VC398400	DIODE	MA185
D116	iF004600	DIODE	1SS133
D117	VG441200	DIODE.ZENR	MTZJ16C 16V
D118	VG441200	DIODE.ZENR	MTZJ16C 16V
D119	VH770800	DIODE	1SR139-100 T-32
D120	VH770800	DIODE	1SR139-100 T-32
D121	VH770800	DIODE	1SR139-100 T-32
D122	VH770800	DIODE	1SR139-100 T-32
D123	VC398400	DIODE	MA185
D124	VM702000	DIODE.BRG	S5VB20 3.5A 200V
D125	iF004600	DIODE	1SS133
D126	VG440400	DIODE.ZENR	MTZJ13A 13V(R)
D127	VH770800	DIODE	1SR139-100 T-32
D128	iF004600	DIODE	1SS133
F101	KB001490	FUSE	10A 250V(R)
F101	KB003100	FUSE	T4.0A 250V(ABHW)
F102	KB000390	FUSE	T4.5A 250V(R)
F103	KB000690	FUSE	T2.5A 250V(HW)
IC101	iG076800	IC	NJM4558S
IC105	XE322001	IC	NJM2068S-D
IC109	XE322001	IC	NJM2068S-D
JK101	LB301720	JACK.PHONE	M1669-A
JK102	Vi327500	OUTLET.AC	3P (R)
JK104	VP728600	OUTLET.AC	3P (HW)
JK105	VJ726800	JACK.MNI	
L101	VC664100	COIL	0.95uH
L102	VC664100	COIL	0.95uH
Q101	VK432900	TR	2SD1915F S,T
Q102	VK432900	TR	2SD1915F S,T
Q103	VK432900	TR	2SD1915F S,T
Q104	VK432900	TR	2SD1915F S,T
Q105	VK432900	TR	2SD1915F S,T
Q106	VK432900	TR	2SD1915F S,T
Q107	iA097000	TR	2SA970 GR,BL
Q108	iA097000	TR	2SA970 GR,BL
Q109	iA097000	TR	2SA970 GR,BL
Q110	iC1815C0	TR	2SC1815 Y
Q111	iC1815C0	TR	2SC1815 Y
Q112	iC1815C0	TR	2SC1815 Y
Q113	iC1815C0	TR	2SC1815 Y
Q114	iA097000	TR	2SA970 GR,BL
Q115	iA097000	TR	2SA970 GR,BL
Q116	iA097000	TR	2SA970 GR,BL
Q117	VL808200	TR	2SA1124 Q,R,S,T
Q118	VL808300	TR	2SC2632 Q,R,S,T

* New Parts

Schm Ref.	PART NO.	Description	
Q119	iA101521	TR	2SA1015 Y
Q120	iA101521	TR	2SA1015 Y
Q121	VL808300	TR	2SC2632 Q,R,S,T
Q122	VL808200	TR	2SA1124 Q,R,S,T
Q123	iC1815C0	TR	2SC1815 Y
Q124	iC1815C0	TR	2SC1815 Y
Q125	iA101521	TR	2SA1015 Y
Q126	iC260320	TR	2SC2603 E,F
Q127	iC260320	TR	2SC2603 E,F
Q128	iC224030	TR	2SC2240 GR,BL
Q129	VL582600	TR	2SD1763A D,E
Q130	VL582500	TR	2SB1186A D,E
Q131	VL582500	TR	2SB1186A D,E
Q132	VL582600	TR	2SD1763A D,E
# Q133	iX620970	TR	2SA1491 O,P,Y
# Q133	iX620980	TR	2SC3855 O,P,Y
# Q134	iX620970	TR	2SA1491 O,P,Y
# Q134	iX620980	TR	2SC3855 O,P,Y
Q141	VL542700	TR.DGT	DTA123JS
Q142	VL542700	TR.DGT	DTA123JS
Q143	iC224030	TR	2SC2240 GR,BL
Q144	iC224030	TR	2SC2240 GR,BL
Q145	VL542700	TR.DGT	DTA123JS
Q146	iA097000	TR	2SA970 GR,BL
Q147	iD043820	TR	2SD438 E,F
Q148	iA101521	TR	2SA1015 Y
Q149	iC224030	TR	2SC2240 GR,BL
Q150	iC257700	TR	2SC2577 O,P,Y(R)
Q151	iC260320	TR	2SC2603 E,F(R)
Q152	VF331200	TR.DGT	DTC124ES
Q153	iB056020	TR	2SB560 E,F
Q154	iC260320	TR	2SC2603 E,F
R105	HV455100	R.CAR.FP	100Ω 1/4W
R110	HV455100	R.CAR.FP	100Ω 1/4W
R127	HV455560	R.CAR.FP	560Ω 1/4W
R129	HV455220	R.CAR.FP	220Ω 1/4W
R130	HV455220	R.CAR.FP	220Ω 1/4W
R131	HV455220	R.CAR.FP	220Ω 1/4W
R132	HV455220	R.CAR.FP	220Ω 1/4W
R134	HV455560	R.CAR.FP	560Ω 1/4W
R149	HV454820	R.CAR.FP	82Ω 1/4W
R150	HV456220	R.CAR.FP	2.2KΩ 1/4W
R151	HV455680	R.CAR.FP	680Ω 1/4W
R152	HV455100	R.CAR.FP	100Ω 1/4W
R153	HV454220	R.CAR.FP	22Ω 1/4W
R154	HV454220	R.CAR.FP	22Ω 1/4W
R155	HV455100	R.CAR.FP	100Ω 1/4W
R156	HV455680	R.CAR.FP	680Ω 1/4W
R157	HV456220	R.CAR.FP	2.2KΩ 1/4W
R158	HV454820	R.CAR.FP	82Ω 1/4W
R161	HV455220	R.CAR.FP	220Ω 1/4W
R164	HV455220	R.CAR.FP	220Ω 1/4W
R167	HV453470	R.CAR.FP	4.7Ω 1/4W

* New Parts

MAIN & FUNCTION P. C. B.

Schm Ref.	PART NO.	Description
R168	HV453470	R. CAR. FP 4.7Ω 1/4W
R169	VJ695400	R. WW 0.22Ωx2 3W
R170	VJ695400	R. WW 0.22Ωx2 3W
R171	HV453470	R. CAR. FP 4.7Ω 1/4W
R172	HV453470	R. CAR. FP 4.7Ω 1/4W
R173	HV453470	R. CAR. FP 4.7Ω 1/4W
R174	HV453470	R. CAR. FP 4.7Ω 1/4W
R175	VJ695400	R. WW 0.22Ωx2 3W
R176	VJ695400	R. WW 0.22Ωx2 3W
R177	HV453470	R. CAR. FP 4.7Ω 1/4W
R178	HV453470	R. CAR. FP 4.7Ω 1/4W
R179	HL316100	R. MTL. OXD 1KΩ 1W
R186	VP939700	R. MTL. OXD 4.7Ω 1W
R189	VP939700	R. MTL. OXD 4.7Ω 1W
R194	HL316100	R. MTL. OXD 1KΩ 1W
R195	HL316100	R. MTL. OXD 1KΩ 1W
R200	HV453220	R. CAR. FP 2.2Ω 1/4W
R201	HV453220	R. CAR. FP 2.2Ω 1/4W
R204	HV453220	R. CAR. FP 2.2Ω 1/4W(W)
R205	HV453220	R. CAR. FP 2.2Ω 1/4W(W)
R206	HV453100	R. CAR. FP 1Ω 1/4W
R207	HV453100	R. CAR. FP 1Ω 1/4W
R212	HU574470	R. MTL. FLM 47Ω 1/4W
R215	HU574470	R. MTL. FLM 47Ω 1/4W
R220	HU574470	R. MTL. FLM 47Ω 1/4W
R223	HU574470	R. MTL. FLM 47Ω 1/4W
R227	HV455220	R. CAR. FP 220Ω 1/4W
R228	HV455220	R. CAR. FP 220Ω 1/4W
R231	HL315470	R. MTL. OXD 470Ω 1W
R232	HL315470	R. MTL. OXD 470Ω 1W
R236	HV454390	R. CAR. FP 39Ω 1/4W
R237	HV454390	R. CAR. FP 39Ω 1/4W
RY101	VK438300	RELAY DH24D2-OTM-II
RY102	VK438300	RELAY DH24D2-OTM-II
RY103	VP378900	RELAY DC DT24D2-OSM
RY104	VD506000	RELAY AC DG12D1-OM
SW101	VL544900	SW. PUSH SPUL 4-2
SW112	VA961800	VOLT. SELCT ESE-37247-F (R)
* SW113	VQ388600	SW. PUSH SPUN12
SW115	VL545200	SW. PUSH SPUN 2-2
T101	XC082A00	TRANS. PWR (R)
T101	XC084A00	TRANS. PWR (ABHW)
TE101	VL920100	TERM. SP 8P (RABW)
TE101	VL920200	TERM. SP 8P (H)
TE102	LA002340	TERM. WRAP 5P i-TYPE (RAB)
TE102	VQ656600	TERM. WRAP 6P i-755NA (HW)
TE105	LA002140	TERM. WRAP 2P i-TYPE P=10
TP101	VB856800	PIN. TEST IPS-1169
VR101	VJ692800	VR. TRIM B470Ω
VR102	VJ692800	VR. TRIM B470Ω
* VR103	VQ457200	VR A100KΩ
	VJ828000	PIN IMSA-6024-03E
	BB071360	SCR TERM 8.3x13

* New Parts

Schm Ref.	PART NO.	Description
	BB070700	GND. MTL
*	VQ335800	P. C. E. FUNCTION (RAB)
*	VQ335900	P. C. E. FUNCTION (H)
*	VQ336000	P. C. E. FUNCTION (W)
CB302	VA252300	CN MQ 5P
CB304	VD005000	CN. BS. PIN PH i-TYPE 7P TE
CB305	VA725800	HOLDER 8P
CB306	VA725800	HOLDER 8P
CB307	VA725800	HOLDER 8P
CB308	VA725800	HOLDER 8P
CB309	VA725800	HOLDER 8P
CB310	VA725800	HOLDER 8P
CB311	VM929900	CN. BS. PIN 52044 15P TE
CB312	VD004600	CN. BS. PIN PH i-TYPE 3P TE
CB313	VD005000	CN. BS. PIN PH i-TYPE 7P TE
CB314	VD004800	CN. BS. PIN PH i-TYPE 5P TE
CB315	VD004500	CN. BS. PIN PH i-TYPE 2P TE
CB316	VM859600	CN. BS. PIN 52045 15P TE
CB317	VB994900	CN MQ 9P
CB319	VP682200	CN 52045 8P TE
CB320	VA725800	HOLDER 8P
CB321	VA725800	HOLDER 8P
C301	VK534000	C. PP 220pF 200V
C302	VK534000	C. PP 220pF 200V
C303	VK534000	C. PP 220pF 200V
C304	VK534000	C. PP 220pF 200V
C305	VG278400	C. CE. TUBLR 220pF 50V
C306	VG278400	C. CE. TUBLR 220pF 50V
C307	VG278400	C. CE. TUBLR 220pF 50V
C308	VG278400	C. CE. TUBLR 220pF 50V
C309	VG278400	C. CE. TUBLR 220pF 50V
C310	VG278400	C. CE. TUBLR 220pF 50V
C311	VG278400	C. CE. TUBLR 220pF 50V
C312	VG278400	C. CE. TUBLR 220pF 50V
C313	VG278400	C. CE. TUBLR 220pF 50V
C314	VG278400	C. CE. TUBLR 220pF 50V
C315	VG288900	C. EL 100uF 25V
C316	UA654560	C. MYLAR 0.056uF 50V
C317	UA654560	C. MYLAR 0.056uF 50V
C318	VG288900	C. EL 100uF 25V
C319	UA654470	C. MYLAR 0.047uF 50V
C320	UA654680	C. MYLAR 0.068uF 50V
C321	UA654680	C. MYLAR 0.068uF 50V
C322	VG290500	C. EL 1uF 50V
C323	UA652680	C. MYLAR 680pF 50V
C324	UA652680	C. MYLAR 680pF 50V
C325	UA654470	C. MYLAR 0.047uF 50V
C326	UA654680	C. MYLAR 0.068uF 50V
C327	UA654680	C. MYLAR 0.068uF 50V
C328	VG290500	C. EL 1uF 50V

* New Parts

FUNCTION P. C. B.

Schm Ref.	PART NO.	Description
C330	VF466700	C.CE.TUBLR 47pF 50V
C331	VG290600	C.EL 2.2uF 50V
C332	UA652220	C.MYLAR 220pF 50V
C333	UA652220	C.MYLAR 220pF 50V
C334	VG290600	C.EL 2.2uF 50V
C335	VF466700	C.CE.TUBLR 47pF 50V
C337	VG291000	C.EL 22uF 50V
C338	UA655120	C.MYLAR 0.12uF 50V
C339	UA654330	C.MYLAR 0.033uF 50V
C340	UA654330	C.MYLAR 0.033uF 50V
C341	UA655120	C.MYLAR 0.12uF 50V
C342	VG291000	C.EL 22uF 50V
C343	VD916400	C.EL 2.2uF 50V
C344	VD930900	C.CE.SMI 0.1uF 25V
C345	VG278400	C.CE.TUBLR 220pF 50V
C346	UA654100	C.MYLAR 0.01uF 50V
C347	VG278400	C.CE.TUBLR 220pF 50V
C348	UA654100	C.MYLAR 0.01uF 50V
C349	VG722100	C.EL 1uF 50V
C350	VG290700	C.EL 3.3uF 50V(HW)
C351	VF466800	C.CE.TUBLR 100pF 50V(RABH)
C351	VG278100	C.CE.TUBLR 120pF 50V(W)
C352	VG290900	C.EL 10uF 50V
C353	VG278600	C.CE.TUBLR 330pF 50V
C354	VG278600	C.CE.TUBLR 330pF 50V
C355	VG290900	C.EL 10uF 50V
C356	VF466800	C.CE.TUBLR 100pF 50V(RABH)
C356	VG278100	C.CE.TUBLR 120pF 50V(W)
C357	VM758800	C.EL 330uF 25V
C358	UM216330	C.EL 3.3uF 50V
C359	Vi460900	C.EL 2200uF 6.3V
C360	UA653270	C.MYLAR 2700pF 50V
C361	UA653270	C.MYLAR 2700pF 50V
C362	Vi460900	C.EL 2200uF 6.3V
C364	UA654330	C.MYLAR 0.033uF 50V
C365	VG288900	C.EL 100uF 25V
C366	UA654330	C.MYLAR 0.033uF 50V
C367	VD930900	C.CE.SMI 0.1uF 25V
C368	UA653240	C.MYLAR 2400pF 50V
C369	UA653680	C.MYLAR 6800pF 50V
C370	VG291000	C.EL 22uF 50V
C371	VG287800	C.EL 330uF 16V
C372	VG287800	C.EL 330uF 16V
C373	VG291000	C.EL 22uF 50V
C374	UA653680	C.MYLAR 6800pF 50V
C375	UA653240	C.MYLAR 2400pF 50V
C376	UA653330	C.MYLAR 3300pF 50V
C377	UA653330	C.MYLAR 3300pF 50V
C380	VD930900	C.CE.SMI 0.1uF 25V
C381	VG290900	C.EL 10uF 50V
C382	VG287800	C.EL 330uF 16V
C383	VG290900	C.EL 10uF 50V
C384	VD930900	C.CE.SMI 0.1uF 25V

* New Parts

Schm Ref.	PART NO.	Description
C385	VF992600	C.EL 4700uF 5.5V
C386	VG290500	C.EL 1uF 50V
C387	VG290900	C.EL 10uF 50V
C388	VD930900	C.CE.SMI 0.1uF 25V(W)
C389	VD930900	C.CE.SMI 0.1uF 25V(W)
C390	VD930900	C.CE.SMI 0.1uF 25V(W)
D302	VF402500	LED(or) SLR-34DC3H3
D303	Vi013600	LED(re) SLR-34VC3H3
D304	iF004600	DIODE 1SS133
D305	iF004600	DIODE 1SS133
D306	iF004600	DIODE 1SS133
D307	iF004600	DIODE 1SS133
D308	iF004600	DIODE 1SS133
D309	iF004600	DIODE 1SS133
D310	VG437000	DIODE.ZENR MTZJ4.7A 4.7V
D311	VG438000	DIODE.ZENR MTZJ6.2B 6.2V
D312	VG437500	DIODE.ZENR MTZJ5.1C 5.1V
D313	VG440300	DIODE.ZENR MTZJ12C 12V
D314	iF004600	DIODE 1SS133
D315	VG438000	DIODE.ZENR MTZJ6.2B 6.2V
D316	iF004600	DIODE 1SS133
D317	VG436800	DIODE.ZENR MTZJ4.3B 4.3V
IC301	XA987001	IC NUM2068D-D
IC305	XF557A00	IC TA7291S
IC306	XM088B00	IC LC6520H-4B14
IC307	XB247301	IC uPC4570HA
IC311	XF557A00	IC TA7291S
L301	VF541100	COIL 15uH
L302	VF541100	COIL 15uH
L303	VB056900	COIL 220uH
L304	VB056900	COIL 220uH
PJ301	VG731500	JACK.PIN 2P
PJ302	VL552800	JACK.PIN 4P
PJ303	VL552800	JACK.PIN 4P
PJ304	VL552800	JACK.PIN 4P
PJ305	VL552800	JACK.PIN 4P
PJ306	LB202260	JACK.PIN 2P
Q301	VD678700	TR.DGT DTC114ES
Q302	VD678700	TR.DGT DTC114ES
Q303	VD678700	TR.DGT DTC114ES(HW)
Q304	iA097000	TR 2SA970 GR,BL
Q305	iA097000	TR 2SA970 GR,BL
Q306	iA101521	TR 2SA1015 Y
Q307	iC174020	TR 2SC1740S R,S
Q308	iA097000	TR 2SA970 GR,BL
Q309	iA097000	TR 2SA970 GR,BL
Q310	VG722000	TR.DGT DTC144ES
Q312	iA093320	TR 2SA933S Q,R
Q315	iA093320	TR 2SA933S Q,R
Q316	iC174020	TR 2SC1740S R,S
Q317	VC407900	TR 2SD1913 R,S
Q318	iA093320	TR 2SA933S Q,R
Q319	iA093320	TR 2SA933S Q,R

* New Parts

FUNCTION P. C. B.

Schm Ref.	PART NO.	Description
Q320	iC206010	TR 2SC2060 P,Q,R
R408	HV454100	R.CAR.FP 10Ω 1/4W
R421	VF066600	R.ARRAY EXB-F9E-473J
R422	HV455100	R.CAR.FP 100Ω 1/4W
R423	HV455100	R.CAR.FP 100Ω 1/4W
R426	HV455100	R.CAR.FP 100Ω 1/4W
R427	HV455100	R.CAR.FP 100Ω 1/4W
SW301	KA805120	SW.PUSH SUN192H
* SW303	VQ291800	SW.RT SRRZS4 4/6
SW307	VJ779400	SW.RT
SW311	VK333500	SW.PUSH SPUN19 6-2
U301	VF926500	L.DTCT GP1U501X
* VR301	VP898400	VR A100KΩ
* VR302	VQ400100	VR MN00KΩ
* VR304	VQ291900	VR B20KΩ
* VR305	VQ292000	VR W20KΩ
* W307	VQ292100	CN.FLAT 8P 140mm
* W308	VQ212000	CN.FLAT 15P 140mm
XL301	VB759100	RSNR.CE 4MHz
	VB966900	CN IMSA-6024
	BB071360	SCR.TERM 8.3x13
	VN985700	LUG.GND MEP10359 #12E07(W)

* New Parts

EXPLODED VIEW

1
2
3
4
5
6

A B C D E F G H

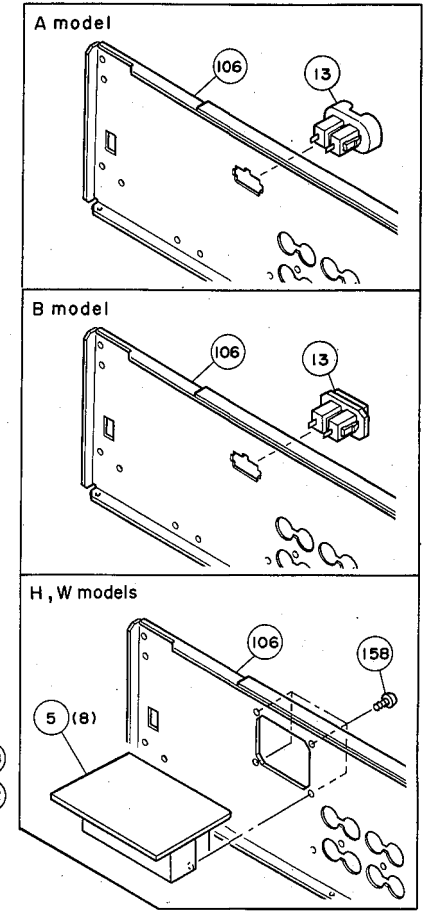
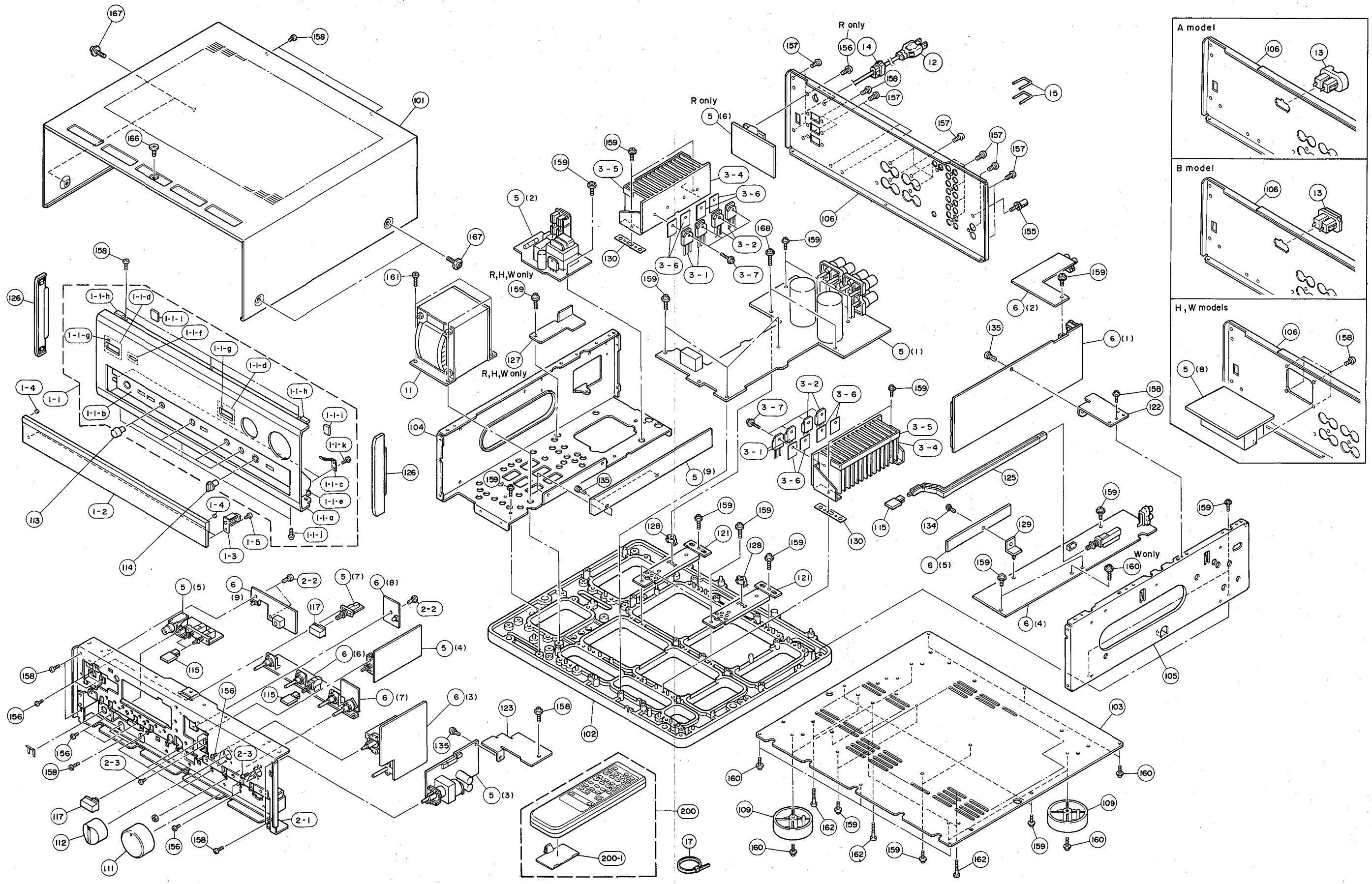

MECHANICAL PARTS Note) Ø : Diameter

Ref. No.	PART NO.	Description	Remarks	Markets
* 1-1	VQ336200	FRONT PANEL ASS'y	BL	
* 1-1	VQ336300	FRONT PANEL ASS'y	TI	
* 1-1-a	VQ157700	FRONT PANEL	BL	
* 1-1-a	VQ157800	FRONT PANEL	TI	
* 1-1-b	VQ157900	PLATE, SEALING	BL	
* 1-1-b	VQ158000	PLATE, SEALING	TI	
1-1-c	VJ888200	SPRING		
1-1-d	VH816700	BUTTON GUIDE	10x25	BL
1-1-d	VH816800	BUTTON GUIDE	10x25	TI
1-1-e	VL216900	CASE, SUB PANEL		BL
1-1-e	VL217000	CASE, SUB PANEL		TI
1-1-f	VH897500	LENS		
1-1-g	VH897700	LENS	2.2Lx2.2	
1-1-h	VE222600	CUSHION		
1-1-i	VE798200	CUSHION		
1-1-j	EX600310	BIND HEAD P-TITE SCREW	3x8 FCRM3-BL	
1-1-k	EX601280	BW HEAD P-TITE SCREW	3x8-8 FCRM3-BL	
* 1-2	VQ158100	SUB PANEL, LID		BL
* 1-2	VQ158200	SUB PANEL, LID		TI
1-3	VJ888000	STOPPER		TI
1-3	VJ888100	STOPPER		BL
1-4	CB621930	DAMPER		BL
1-4	VE798100	DAMPER		TI
1-5	ED330066	BIND HEAD SCREW	3x6 FCRM3-BL	
* 2-1	VQ158300	SUB CHASSIS		
2-2	CB605620	PLASTIC RIVET	No.1781	
2-3	ED330066	BIND HEAD SCREW	3x6 FCRM3-BL	
3-1	ix620970	TRANSISTOR	2SA1491 O,P,Y	Q133A,Q134A
3-2	ix620980	TRANSISTOR	2SC3855 O,P,Y	Q133C,Q134C
* 3-4	VQ321100	HEAT SINK ASS'y		
3-5	VK689900	DAMPER		
3-6	VK195900	SHEET	19x24	
3-7	VK173200	SCREW, TRANSISTOR	3x15 SP FCM3	
* 5	VQ335400	P.C.B. ASS'y MAIN		(R)
* 5	VQ335500	P.C.B. ASS'y MAIN		(AB)
* 5	VQ335600	P.C.B. ASS'y MAIN		(H)
* 5	VQ335700	P.C.B. ASS'y MAIN		(W)
* 6	VQ335800	P.C.B. ASS'y FUNCTION		(RAB)
* 6	VQ335900	P.C.B. ASS'y FUNCTION		(H)
* 6	VQ336000	P.C.B. ASS'y FUNCTION		(W)
* 11	XJ694B00	POWER TRANSFORMER		(R)
* 11	XJ695B00	POWER TRANSFORMER		(AB)
* 11	XJ696B00	POWER TRANSFORMER		(HW)
12	VE043100	POWER CORD ASS'y		(B)
12	VE222900	POWER CORD ASS'y		(R)
12	VE223200	POWER CORD ASS'y		(HW)
12	VP418100	POWER CORD ASS'y		(A)
13	VJ775000	AC OUTLET	2P	(B)
13	VP418700	AC OUTLET	2P	(A)
14	VD375900	CORD STOPPER	No. 2271	
* 15	VQ194100	SHORT PLUG	CNT31-0	
17	CB069250	BINDING TIE	BK-1	
101	VL212800	TOP COVER		BL

* New Parts

Ref. No.	PART NO.	Description	Remarks	Markets
101	VL213000	TOP COVER		TI
102	VL213100	CHASSIS, ART BASE		
103	VL213600	BOTTOM COVER		
104	VL213700	FRAME	SIDE L	
105	VL213800	FRAME	SIDE R	
* 106	VQ158400	REAR PANEL		(R)
* 106	VQ158500	REAR PANEL		(AB)
* 106	VQ158600	REAR PANEL		(W)
* 106	VQ158700	REAR PANEL		(H)
109	VK016500	LEG	Ø60xH21	
111	VK015100	KNOB, LED	Ø45	BL VOLUME
111	VK015200	KNOB, LED	Ø45	TI VOLUME
112	VK219900	KNOB, LED	Ø32	BL INPUT
112	VK220000	KNOB, LED	Ø32	TI INPUT
113	VG078900	KNOB	Ø12	BL BASS, TREBLE
113	VP559700	KNOB	Ø12	TI BASS, TREBLE
114	VG079100	KNOB	Ø12	BL REC_OUT
114	VP564400	KNOB	Ø12	TI REC_OUT
115	VM736600	BUTTON	3x14	BL S.FILTER
115	VP564500	BUTTON	3x14	TI S.FILTER
117	VH841900	BUTTON	10x25	BL POWER
117	VP663400	BUTTON	10x25	TI POWER
* 121	VQ326500	SUPPORT, H.SINK		
* 122	VQ364300	SUPPORT, PCB		
123	VL215000	FRAME	PCB2	
125	VL250600	EXTENSION BAR		
126	VJ833000	SIDE COVER		TI
126	VJ833100	SIDE COVER		BL
* 127	VQ895600	SHEILD PLATE		(RHW)
128	VN130700	SPACER		
129	CB091290	SUPPORT, P.C.B.	No.1645	
* 130	VQ550500	SPACER, HEAT SINK		
134	CB068880	PLASTIC RIVET	No.1027	
135	CB605620	PLASTIC RIVET	No.1781	
155	AA627310	GROUND TERMINAL		
156	ED330066	BIND HEAD SCREW	3x6 FCRM3-BL	
157	EN301010	BIND HEAD BONDING TAP. SCREW	3x8 FCRM3-BL	
158	Ei330086	BIND HEAD B-TITE SCREW	3x8 FCRM3-BL	
159	VB770200	BW HEAD P-TITE SCREW	3x10-8 FCM3	
160	EX602240	BW HEAD TAPPING SCREW	3x10	
161	EN330060	BIND HEAD B-TITE SCREW	4x16 FCRM3-BL	
162	Ei340256	BIND HEAD TAPPING SCREW	4x25 ZMC2-BL	
166	EX601850	SPECIAL SCREW S-TITE	4x8-10 FCRM3-BL	BL
166	EX601860	SPECIAL SCREW S-TITE	4x8-10 FNM3-BL	TI
167	EL300470	BW HEAD S-TITE SCREW	4x8-10 FCRM3-BL	BL
167	EX601150	BW HEAD S-TITE SCREW	4x8-10 FNM3-BL	TI
168	EL300480	BW HEAD B-TITE SCREW	3x15-8 FCRM3-BL	
		ACCESSORIES		
* 200	VP849500	REMOTE CONTROL TRANSMITTER		
200-1	CX673000	LID	56x33KURON	K-PM2-385-1
		BATTERY, MANGANESE	SUM-3, AA, R06	

* New Parts

AX-870

REMOTE CONTROL TRANSMITTER

■ SCHEMATIC DIAGRAM

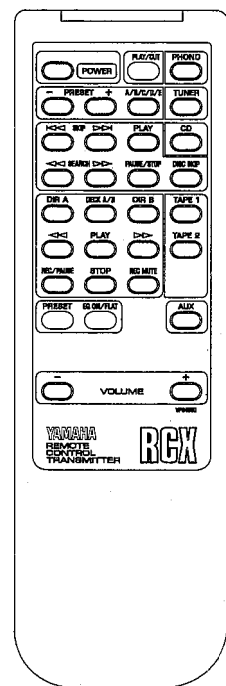
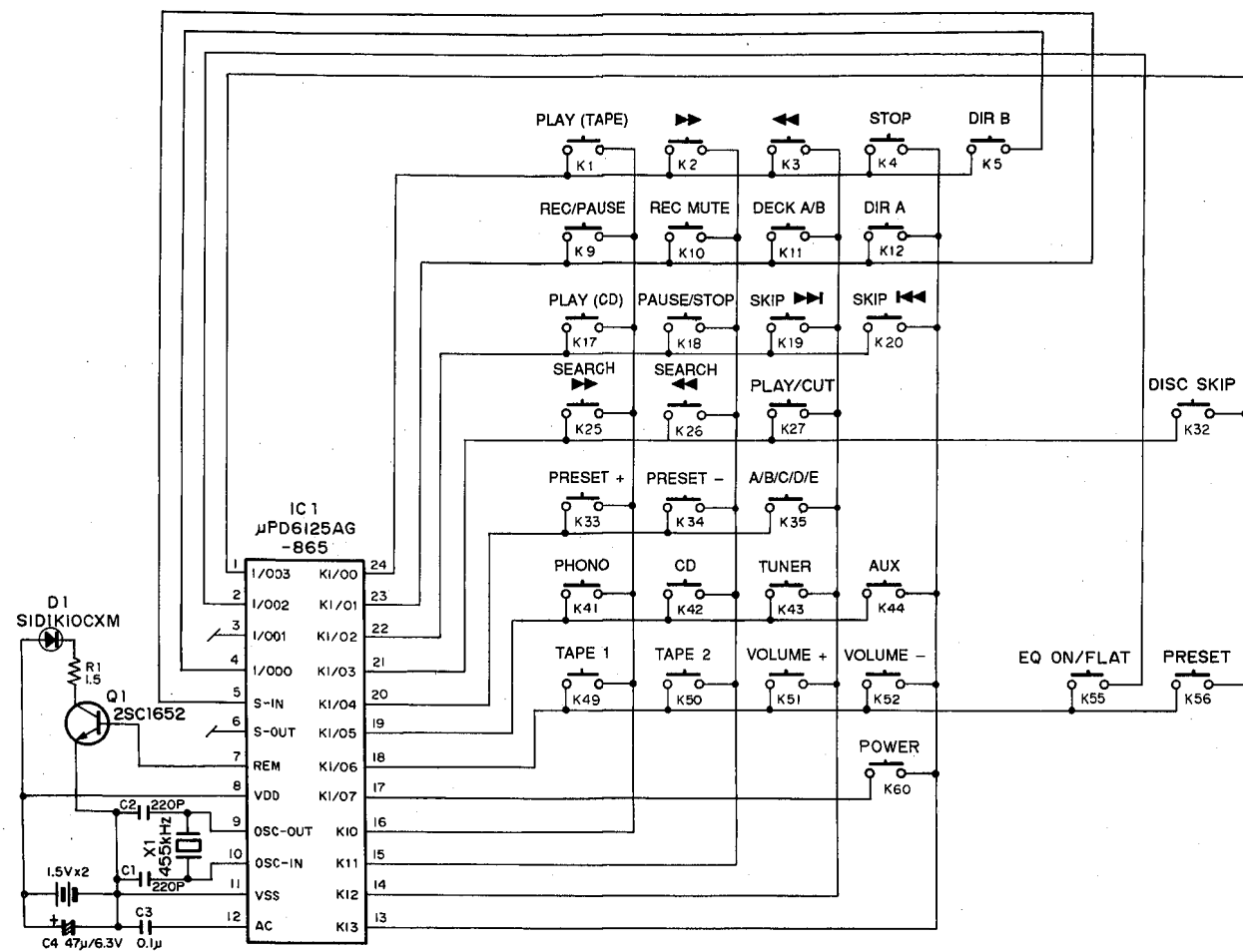

Key No.	CUSTOM (HEX)	DATA (HEX)	FUNCTION	Key No.	CUSTOM (HEX)	DATA (HEX)	FUNCTION
1	7A	00	PLAY (TAPE)	32	7A	4F	DISC SKIP (CD)
2	7A	01	◀ (TAPE)	33	7A	10	PRESET + (TUNER)
3	7A	02	▶ (TAPE)	34	7A	11	PRESET - (TUNER)
4	7A	03	STOP (TAPE)	35	7A	12	A/B/C/D/E (TUNER)
5	7A	04	DIR B (TAPE)	41	7A	14	PHONO (INPUT)
9	7A	04	REC/PAUSE (TAPE)	42	7A	15	CD (INPUT)
10	7A	05	REC MUTE (TAPE)	43	7A	16	TUNER (INPUT)
11	7A	06	DECK A/B (TAPE)	44	7A	17	AUX (INPUT)
12	7A	07	DIR A (TAPE)	49	7A	18	TAPE 1 (INPUT)
17	7A	08	PLAY (CD)	50	7A	19	TAPE 2 (INPUT)
18	7A	09	PAUSE/STOP (CD)	51	7A	1A	VOLUME +
19	7A	0A	SKIP ▶▶ (CD)	52	7A	1B	VOLUME -
20	7A	0B	SKIP ◀◀ (CD)	55	7A	5A	EQ ON/FLAT (EQ)
25	7A	0C	SEARCH ▶▶ (CD)	56	7A	5B	PRESET (EQ)
26	7A	0D	SEARCH ◀◀ (CD)	60	7A	1F	POWER
27	7A	0E	PLAY/CUT (PHONO)				

Parts List for Carbon Resistors

Value	1/4W Type Part No.	1/6W Type Part No.	Value	1/4W Type Part No.	1/6W Type Part No.
1.0 Ω	HJ35 3100	HF85 3100	10 kΩ	HF45 7100	HF45 7100
1.8 Ω	HJ35 3180	*	11 kΩ	HF45 7110	HF45 7110
2.2 Ω	HJ35 3220	HF85 3220	12 kΩ	HJ35 7120	HF85 7120
3.3 Ω	HJ35 3330	HF85 3330	13 kΩ	HF45 7130	HF45 7130
4.7 Ω	HJ35 3470	HF85 3470	15 kΩ	HF45 7150	HF45 7150
5.6 Ω	HJ35 3560	HF85 3560	18 kΩ	HF45 7180	HF45 7180
10 Ω	HF45 4100	HF45 4100	22 kΩ	HF45 7220	HF45 7220
15 Ω	HJ35 4150	HF85 4150	24 kΩ	HF45 7240	HF45 7240
22 Ω	HF45 4220	HF45 4220	27 kΩ	HJ35 7270	HF85 7270
27 Ω	HJ35 4270	HF85 4270	30 kΩ	HF45 7300	HF45 7300
33 Ω	HF45 4330	HF45 4330	33 kΩ	HF45 7330	HF45 7330
39 Ω	HJ35 4470	HF85 4390	36 kΩ	HF45 7360	HF45 7360
47 Ω	HF45 4470	HF45 4470	39 kΩ	HF45 7390	HF45 7390
56 Ω	HF45 4560	HF45 4560	47 kΩ	HF45 7470	HF45 7470
68 Ω	HF45 4680	HF45 4680	51 kΩ	HF45 7510	HF45 7510
75 Ω	HF45 4750	HF45 4750	56 kΩ	HF45 7560	HF45 7560
82 Ω	HF45 4820	HF45 4820	62 kΩ	HF45 7620	HF45 7620
91 Ω	HF45 4910	HF45 4910	68 kΩ	HF45 7680	HF45 7680
100 Ω	HF45 5100	HF45 5100	82 kΩ	HF45 7820	HF45 7820
110 Ω	HJ35 5110	HF85 5110	91 kΩ	HF45 7910	HF45 7910
120 Ω	HF45 5120	HF45 5120	100 kΩ	HF45 8100	HF45 8100
150 Ω	HF45 5150	HF45 5150	110 kΩ	HF45 8110	HF45 8110
160 Ω	HJ35 5160	*	120 kΩ	HF45 8120	HF45 8120
180 Ω	HF45 5180	HF45 5180	150 kΩ	HF45 8150	HF45 8150
200 Ω	HF45 5200	HF45 5200	180 kΩ	HF45 8180	HF45 8180
220 Ω	HF45 5220	HF45 5220	220 kΩ	HJ35 8220	HF85 8220
270 Ω	HF45 5270	HF45 5270	270 kΩ	HF45 8270	HF45 8270
330 Ω	HF45 5330	HF45 5330	300 kΩ	HF45 8300	HF45 8300
390 Ω	HF45 5390	HF45 5390	330 kΩ	HF45 8330	HF45 8330
430 Ω	HF45 5430	HF45 5430	390 kΩ	HJ35 8390	HF85 8390
470 Ω	HF45 5470	HF45 5470	470 kΩ	HF45 8470	HF45 8470
510 Ω	HF45 5510	HF45 5510	560 kΩ	HJ35 8560	HF85 8560
560 Ω	HF45 5560	HF45 5560	680 kΩ	HJ35 8680	HF85 8680
680 Ω	HF45 5680	HF45 5680	820 kΩ	HJ35 8820	HF85 8820
820 Ω	HF45 5820	HF45 5820	1.0 MΩ	HF45 9100	HF45 9100
910 Ω	HF45 5910	HF45 5910	1.2 MΩ	HJ35 9120	*
1.0 kΩ	HF45 6100	HF45 6100	1.5 MΩ	HJ35 9150	HF85 9150
1.2 kΩ	HF45 6120	HF45 6120	1.8 MΩ	HJ35 9180	HF85 9180
1.5 kΩ	HF45 6150	HF45 6150	2.2 MΩ	HJ35 9220	HF85 9220
1.8 kΩ	HF45 6180	HF45 6180	3.3 MΩ	HJ35 9330	HF85 9330
2.0 kΩ	HJ35 6200	HF85 6200	3.9 MΩ	HJ35 9390	*
2.2 kΩ	HF45 6220	HF45 6220	4.7 MΩ	HJ35 9470	HF85 9470
2.4 kΩ	HJ35 6240	HF85 6240			
2.7 kΩ	HF45 6270	HF45 6270			
3.0 kΩ	HF45 6300	HF45 6300			
3.3 kΩ	HF45 6330	HF45 6330			
3.6 kΩ	HJ35 6360	HF85 6360			
3.9 kΩ	HF45 6390	HF45 6390			
4.7 kΩ	HF45 6470	HF45 6470			
5.1 kΩ	HF45 6510	HF45 6510			
5.6 kΩ	HF45 6560	HF45 6560			
6.8 kΩ	HF45 6680	HF45 6680			
8.2 kΩ	HF45 6820	HF45 6820			
9.1 kΩ	HF45 6910	HF45 6910			

